

**SCX  
2000-3**

---

**HYDRAULIC CRAWLER CRANE**

# アタッチメントバリエーション

ロープ速度*	フロント (W1) / リヤ (W2)	m / min	110
	ブーム起伏 (W3)		24 × 2
	タワージブ起伏 (W2)		39
旋回速度*		min <sup>-1</sup> (rpm)	1.3 (1.3)
走行速度 高 / 低*		km/h	1.1 / 0.5
登坂能力		% (度)	30 (17)
エンジン名称			カミンズ QSL9 (オフロード法 2014 年基準適合)
定格出力		kW / min <sup>-1</sup> (ps/rpm)	272 / 2,000 (370 / 2,000)

## 【注】

\*印は負荷により速度変化します。

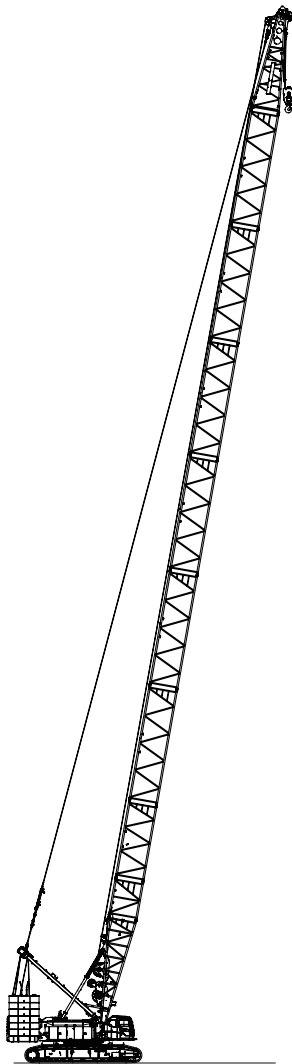

クレーン仕様ブーム最長

ブーム長さ	m	16 ~ 79
接地圧	kPa (kgf/cm <sup>2</sup> )	125 (1.27) (35 t フック付)
全装備質量	t	約 224

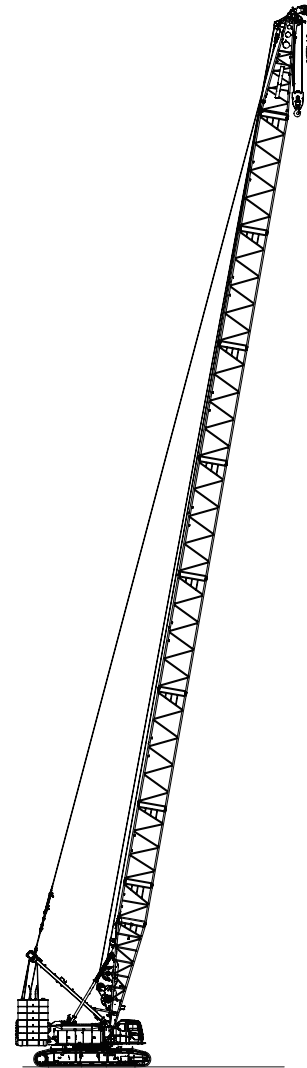

クレーン仕様 補助シーブ付きブーム最長

ブーム長さ	m	16 ~ 79
接地圧	kPa (kgf/cm <sup>2</sup> )	126 (1.29) (35 t + 13.5 t フック付)
全装備質量	t	約 226

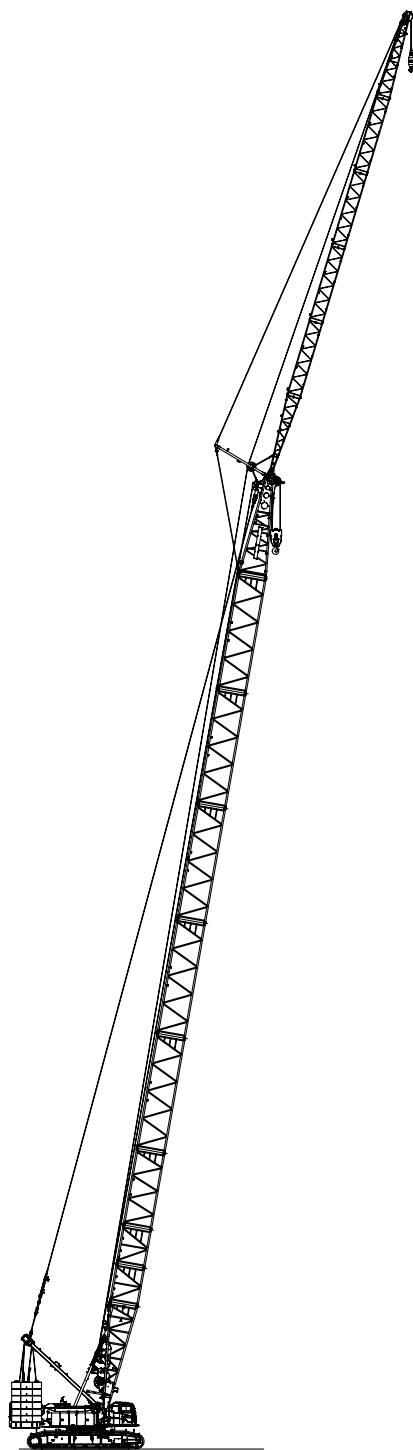

クレーン仕様 クレーンジブ付きboom最長

boom長さ	m	46 ~ 73
クレーンジブ長さ	m	13 ~ 37
boom+クレーンジブ最長	m	73 + 37
接地圧	kPa (kgf/cm <sup>2</sup> )	127 (1.30) 35t + 13.5t フック付
全装備質量	t	約 228

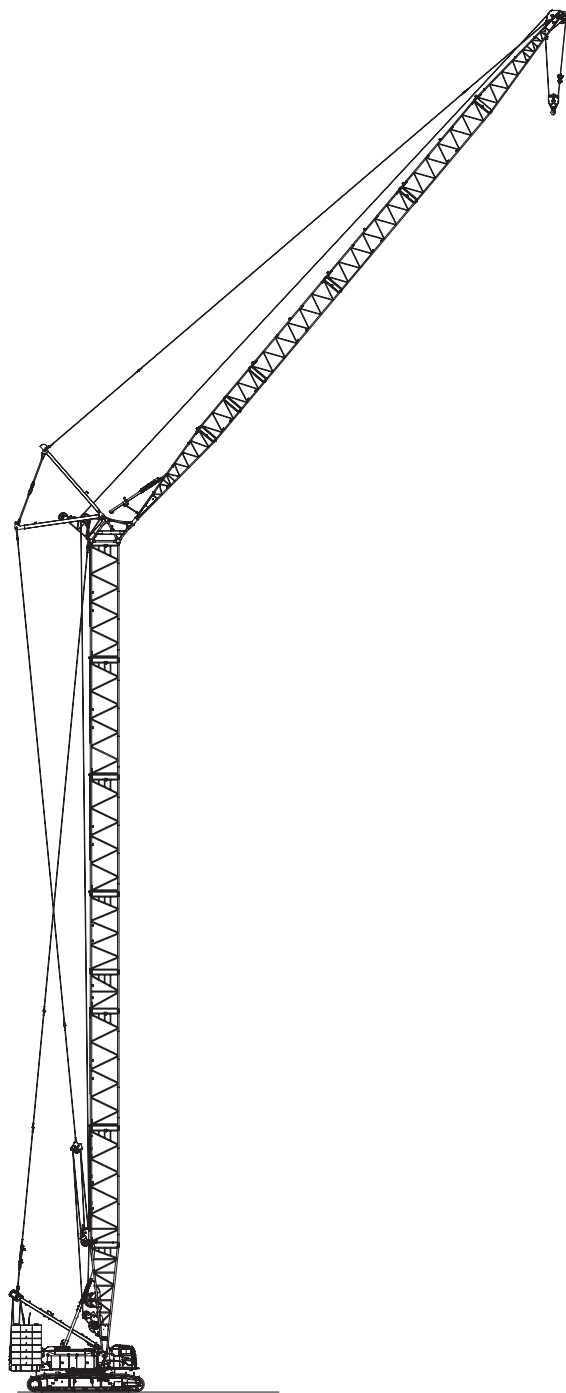

タワー仕様 タワー+タワーjib最長

タワー長さ	m	37 ~ 64
タワーjib長さ	m	27 ~ 51
タワー+タワーjib最長	m	64 + 51
接地圧	kPa (kgf/cm <sup>2</sup> )	130 (1.32) (35 t フック付)
全装備質量	t	約 233

## バリエーション

アタッチメントバリエーション	2
----------------	---

## 仕 様

仕 様	6
-----	---

クレーン仕様	7
--------	---

寸法図／仕様	7
--------	---

ブームの標準構成表	8
-----------	---

クレーンジブ取付可能ブーム長さ（オフセット角 10°および 30°）	10
------------------------------------	----

作業範囲図	12
-------	----

■主ブーム（クレーン専用ブーム）	12
------------------	----

■補助シーブ（クレーン専用ブーム）	13
-------------------	----

■クレーンジブ（クレーン専用ブーム・タワー併用ブーム共通）	14
-------------------------------	----

定格総荷重表	15
--------	----

■主ブーム（クレーン専用ブーム）	15
------------------	----

■補助シーブ（クレーン専用ブーム）	17
-------------------	----

■補助シーブ付き主ブーム（クレーン専用ブーム）	18
-------------------------	----

■クレーンジブ（クレーン専用ブーム・タワー併用ブーム共通）	19
-------------------------------	----

■クレーンジブ付き主ブーム（クレーン専用ブーム・タワー併用ブーム共通）	29
-------------------------------------	----

作業範囲図	34
-------	----

■主ブーム（タワー併用ブーム）	34
-----------------	----

■補助シーブ（タワー併用ブーム）	35
------------------	----

定格総荷重表	36
--------	----

■主ブーム（タワー併用ブーム）	36
-----------------	----

■補助シーブ（タワー併用ブーム）	38
------------------	----

■補助シーブ付き主ブーム（タワー併用ブーム）	39
------------------------	----

タワー仕様	40
-------	----

寸法図／仕様	40
--------	----

タワーの標準構成表	41
-----------	----

作業範囲図	43
-------	----

定格総荷重表	44
--------	----

■ 37 m タワー	44
------------	----

■ 40 m タワー	44
------------	----

■ 40 m タワー	45
------------	----

■ 43 m タワー	45
------------	----

■ 43 m タワー	46
------------	----

■ 46 m タワー	46
------------	----

■ 46 m タワー	47
------------	----

■ 49 m タワー .....	48
■ 52 m タワー .....	49
■ 52 m タワー .....	50
■ 55 m タワー .....	52
■ 58 m タワー .....	55
■ 61 m タワー .....	59
■ 64 m タワー .....	63

## テクニカルデータ

<b>分解時の質量と外形寸法</b> .....	<b>66</b>
質量・外形寸法一覧表 .....	66
<b>装備品一覧</b> .....	<b>71</b>
標準装備・オプション一覧 .....	71

## 仕 様

## エンジン

エンジン名称	カミンズ QSL9
エンジンタイプ	4 サイクル、水冷式、直接噴射式、ターボチャージャー付ディーゼルエンジン
排気量	8.9 L
定格出力	272 kW / 2,000 min <sup>-1</sup> (370 ps / 2,000 rpm)
燃料タンク容量	500 L
備考	米国、欧州、日本のエンジン排出ガス規制 Stage IV / Tier4f / オフロード法 2014 年基準に適合。

## コントロール

コントロールシステム	パイロット油圧制御方式により、油圧システムを制御する。 作業速度は、コントロールレバーのストロークと、ボリュウムダイヤルにより高い精度で制御される。油圧制御と電子装置を組み合わせた安全装置を搭載。
コントロールレバー	人間工学に基づく設計と配置。アームチェアレバーが標準装備。
モニターディスプレイ	8 インチサイズ。 オペレータの視界を妨げることなく、作業状態を確認できるように配置。

## 油圧システム

作動油タンク容量	300 L		
油圧ポンプ	最大圧力	31.4 MPa	
	P1	320 l/min	W2 (ジブ起伏)、W3 (ブーム起伏)、走行右
	P2	320 l/min	W1 (フロント)、W2 (リヤ)、走行左、クイックドロワー
	P3	158 l/min	旋回、リーピングウインチ、各種シリンダ
	P4	74 l/min	ファン駆動 (ラジエタ、オイルクーラ)
	P5	44 l/min	パイロット

## ウインチ

フロント (W1)、リヤ (W2) ウインチ			
ウインチ	フロント	リヤ	
ロープ径	28 mm	28 mm	
ロープ巻取り長さ	標準	410 m	170 m
	最大 (非作業時)	-	290 m
ロープ引張力	定格	598 m	598 m
ロープ引張力	定格	132 kN	132 kN
標準装備	低負荷時には、エンジン回転数が低いエコモードにより、高速ウインチ動作が可能。		
ブーム起伏 (W3) ウインチ			
ロープ径	28 mm		
ロープ巻取り長さ	300 m		
備考	マルチディスクブレーキ付油圧モータ		

## 旋回装置

速度: 1.3 rpm
湿式多板ブレーキ付油圧モーター + 遊星減速機 2 セットおよび外歯歯車付旋回ベアリングで構成。旋回ブレーキ操作ペダル (オプション) により、より精度の高い制御が可能。

## マスト

フロントアタッチメントの組立を容易化。クローラ自力着脱用クイックドロワー (オプション) により可能。 (クイックドロワー使用により、補助クレーンによる組立つり上げ重量最大 12.5 t : リヤフレーム)
--

## カウンタウエイト

カウンタウエイト	総重量	105 t
	ベースウエイト	9.80 t × 1 個
	ウエイト	7.95 t × 12 個

## カーボディ

高張力鋼による溶接ボックス構造。 ジャッキアップ装置およびクローラ連結装置付き。
---

## クローラサイドフレーム

クローラサイドフレーム	溶接ボックス構造。 フック & ピンジョイント式クローラサイドフレーム	
シュー	1120 mm 幅一体シュー	
上部ローラ	片側 4 個 両フランジ型 × 2 個 片持型 × 2 個	
下部ローラ	片側 13 個 両フランジ型、鍛造、フローティングシール型 (潤滑油内蔵) プレーンベアリング	
走行装置	片側 1 個 湿式多板ブレーキ付油圧モーター + 遊星減速機	
	走行速度	高速: 1.1 km/h 低速: 0.5 km/h
	登坂能力	30%

# クレーン仕様

## 寸法図/仕様

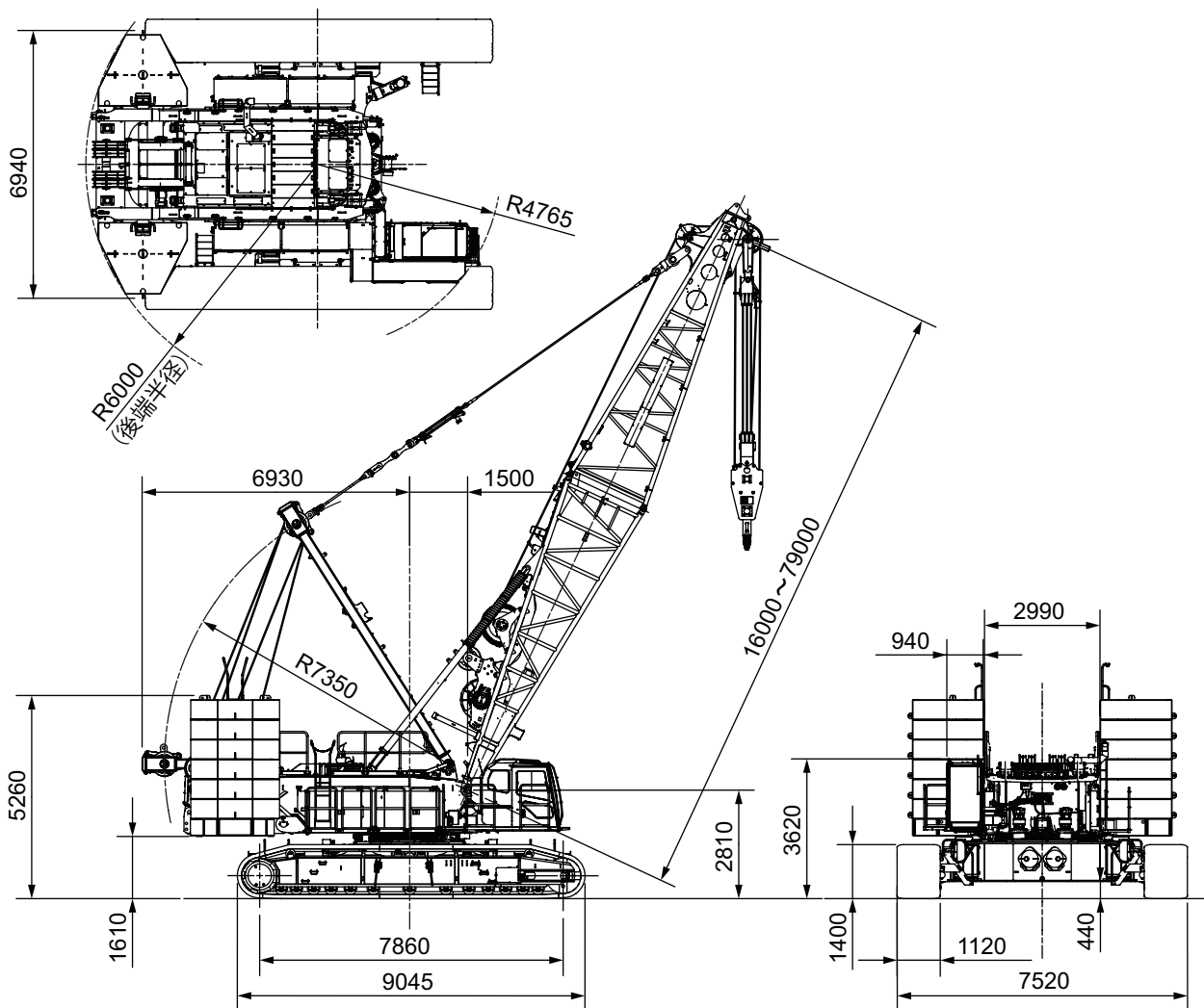

### クレーン仕様

最大つり上げ荷重×作業半径	t × m	200 × 5.0
基本ブーム長さ	m	16
最長ブーム長さ	m	79
クレーンジブ長さ	m	13 ~ 37
ブーム+クレーンジブ最長	m	73 + 37
接地圧	kPa (kgf/cm <sup>2</sup> )	118 (1.20) (16mブーム 200tフック付)
全装備質量	t	212 (16mブーム 200tフック付)

### フック質量

200 t	3,000 kg
135 t	2,600 kg
80 t	2,000 kg
35 t	1,070 kg
13.5 t	620 kg

### 【注】

単位は、国際単位系 (SI) による表示です。( ) 内は、従来の単位表示を参考値として併記しました。

### フロント・リヤウインチロープ掛数と定格総荷重

フック容量	定格総荷重の最大値 (t)											
	16本掛	14本掛	12本掛	10本掛	8本掛	7本掛	6本掛	5本掛	4本掛	3本掛	2本掛	1本掛
200 t	200	185	162	—	—	—	—	—	—	—	—	—
135 t	—	—	—	135	108	94.5	81	67.5	54	40.5	27	—
80 t	—	—	—	—	—	—	80	67.5	54	40.5	27	—
35 t	—	—	—	—	—	—	—	—	—	35	27	—
13.5 t	—	—	—	—	—	—	—	—	—	—	—	13.5

# ブームの標準構成表

## クレーン専用ブーム

ブーム (1/2)	
ブーム長さ (m)	ブーム構成
16	
19	
22	
25	
28	
31	
34	
37	
40	
43	
46	

ブーム (2/2)	
ブーム長さ (m)	ブーム構成
49	
52	
55	
58	
61	
64	
67	
70	
73	
76	
79	

**補助シーブ取付可能ブーム長さ**

ブーム長さ (m)	16	19	22	25	28	31	34	37	40	43	46	49	52	55	58	61	64	67	70	73	76	79	
補助シーブ取付	○	○	○	○	○	○	○	○	○	○	○	○	○	○	○	○	○	○	○	○	○	○	○

(○:可 ×:不可)

**図示省略寸法**

略記号	ブーム長さ (m)	備考
3	3	
6	6	
7.5	7.5	
8.5	8.5	
9	9	

ロープかきめ部の刻印により、ブームペンダントロープを判別してください。

**ペンダントロープ**

略記号	長さ (m)	ロープ径 (mm)	刻印
3	3	35.5	35.5mm 3M
5.71	5.71 (両端メス金具)	35.5	35.5mm 5.71M
6	6	35.5	35.5mm 6M
9	9	35.5	35.5mm 9M

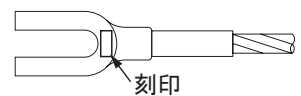



## タワー併用ブーム

9B は 9C に置き換え可能です。  
9C は 9 に置き換え可能です。

ブーム (1/2)	
ブーム長さ (m)	ブーム構成
16	
19	
22	
25	
28	
31	
34	
37	
40	
43	
46	

ブーム (2/2)	
ブーム長さ (m)	ブーム構成
49	
52	
55	
58	
61	
64	
67	
70	
73	
76	
79	

### 補助シーブ取付可能ブーム長さ

ブーム長さ (m)	16	19	22	25	28	31	34	37	40	43	46	49	52	55	58	61	64	67	70	73	76	79	
補助シーブ取付	○	○	○	○	○	○	○	○	○	○	○	○	○	○	○	○	○	○	○	○	○	○	○

(○: 可 ×: 不可)

### 図示省略寸法

略記号	ブーム長さ (m)	備考
3	3	
6	6	
7.5	7.5	
8.5	8.5	
9	9	
9B	9	ジブ下部スプレッド取付用
9C	9	レール付

ロープかしまり部の刻印により、ブームペンダントロープを判別してください。

### ペンダントロープ

略記号	長さ (m)	ロープ径 (mm)	刻印
3	3	35.5	35.5mm 3M
5.71	5.71 (両端メス金具)	35.5	35.5mm 5.71M
6	6	35.5	35.5mm 6M
9	9	35.5	35.5mm 9M

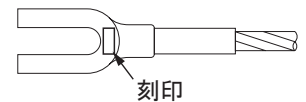

## クレーンジブ取付可能ブーム長さ (オフセット角 10° および 30°)

クレーンジブ取付可能ブーム長さ											
クレーンジブ長さ (m)	13		19		25		31		37		
オフセット角 (°)	10	30	10	30	10	30	10	30	10	30	
ブーム長さ (m)	16	×	×	×	×	×	×	×	×	×	
	19	×	×	×	×	×	×	×	×	×	
	22	×	×	×	×	×	×	×	×	×	
	25	×	×	×	×	×	×	×	×	×	
	28	×	×	×	×	×	×	×	×	×	
	31	×	×	×	×	×	×	×	×	×	
	34	×	×	×	×	×	×	×	×	×	
	37	×	×	×	×	×	×	×	×	×	
	40	×	×	×	×	×	×	×	×	×	
	43	×	×	×	×	×	×	×	×	×	
	46	○	○	○	○	○	○	○	○	○	
	49	○	○	○	○	○	○	○	○	○	
	52	○	○	○	○	○	○	○	○	○	
	55	○	○	○	○	○	○	○	○	○	
	58	○	○	○	○	○	○	○	○	○	
	61	○	○	○	○	○	○	○	○	○	
	64	○	○	○	○	○	○	○	○	○	
	67	○	○	○	○	○	○	○	○	○	
70	○	○	○	○	○	○	○	○	○		
73	○	○	○	○	○	○	○	○	○		
76	×	×	×	×	×	×	×	×	×		
79	×	×	×	×	×	×	×	×	×		

(○ : 可 × : 不可)

クレーンジブ (オフセット角 10°および 30°)

クレーンジブ長さ (m)	オフセット角度	クレーンジブ構成
13	10°	
	30°	
19	10°	
	30°	
25	10°	
	30°	
31	10°	
	30°	
37	10°	

図示省略寸法

略記号	ジブ長さ (m)	備考
6	6	
6.5	6.5	

ロープかしめ部の刻印により、ジブペンダントロープを判別してください。

ジブペンダントロープ

略記号	長さ (m)	ロープ径 (mm)	刻印
1.7	1.70	32	□・△・32・1.7・S
5.85	5.85	32	□・△・32・5.8・S
9.35	9.35	35.5	□・△・35.5・9.35・S

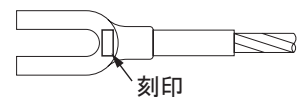

作業範囲図

■主ブーム (クレーン専用ブーム)

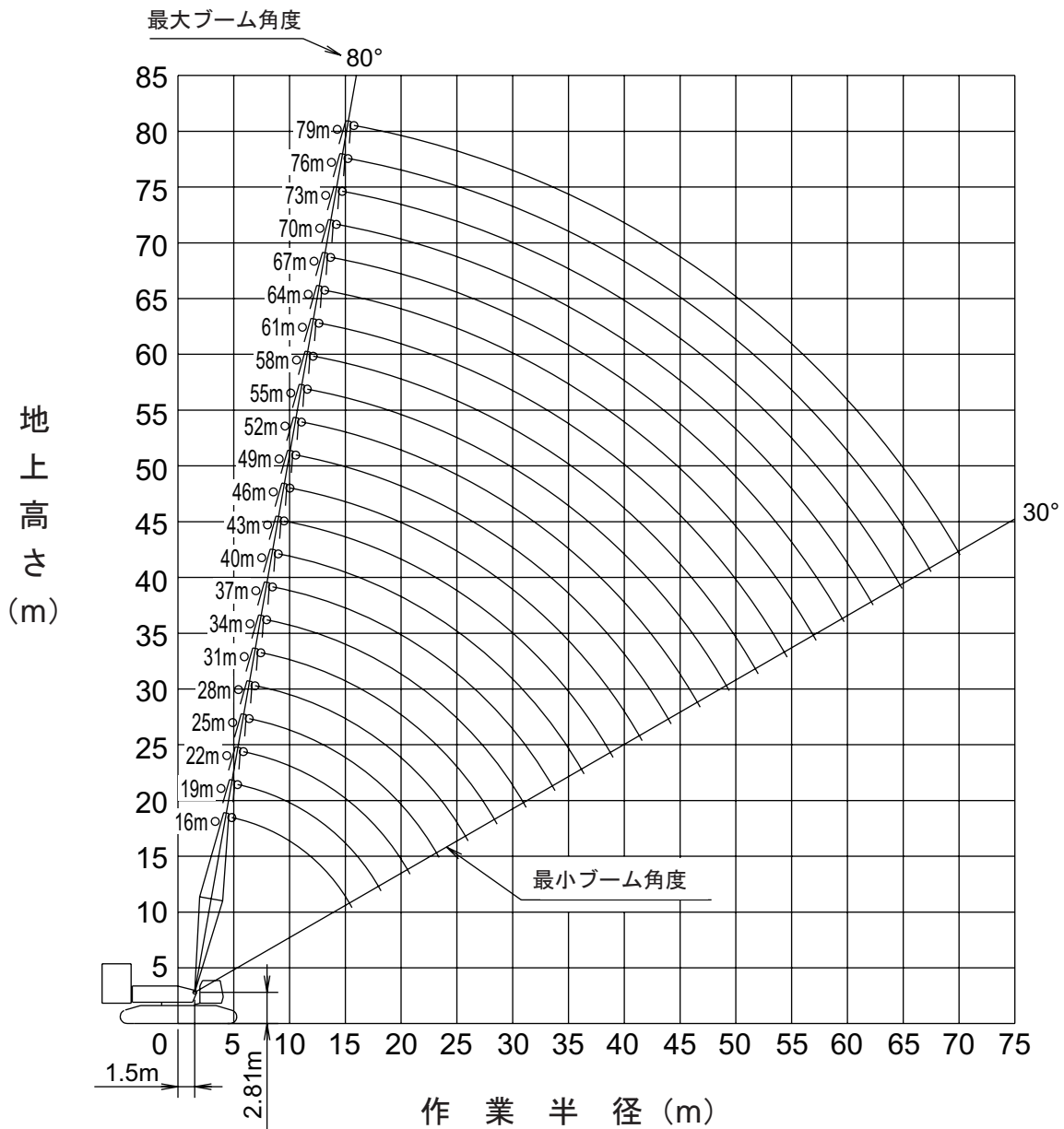
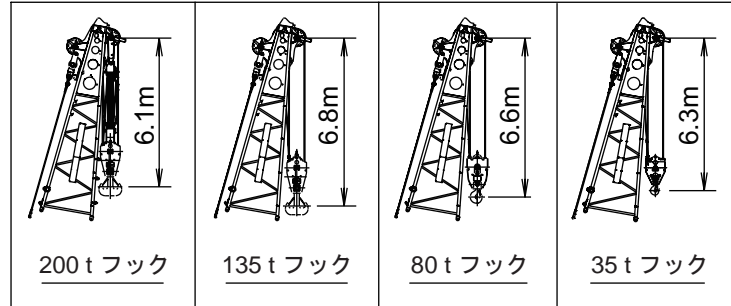

■補助シーブ (クレーン専用ブーム)

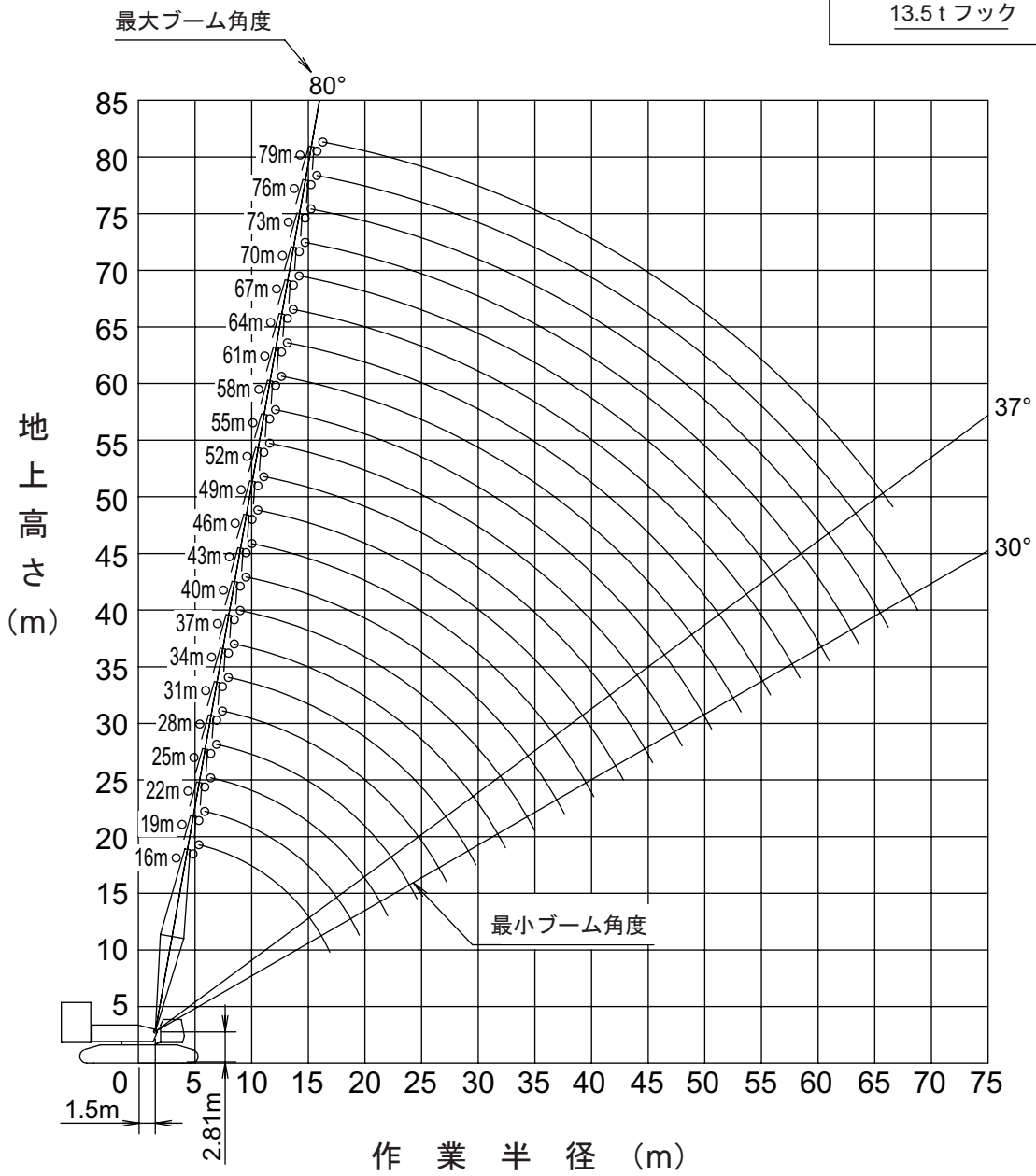
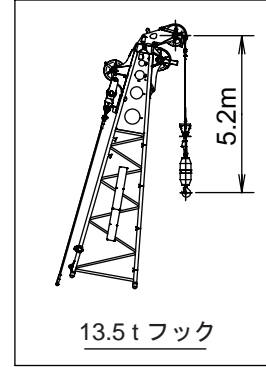

## ■クレーンジブ (クレーン専用ブーム・タワー併用ブーム共通)

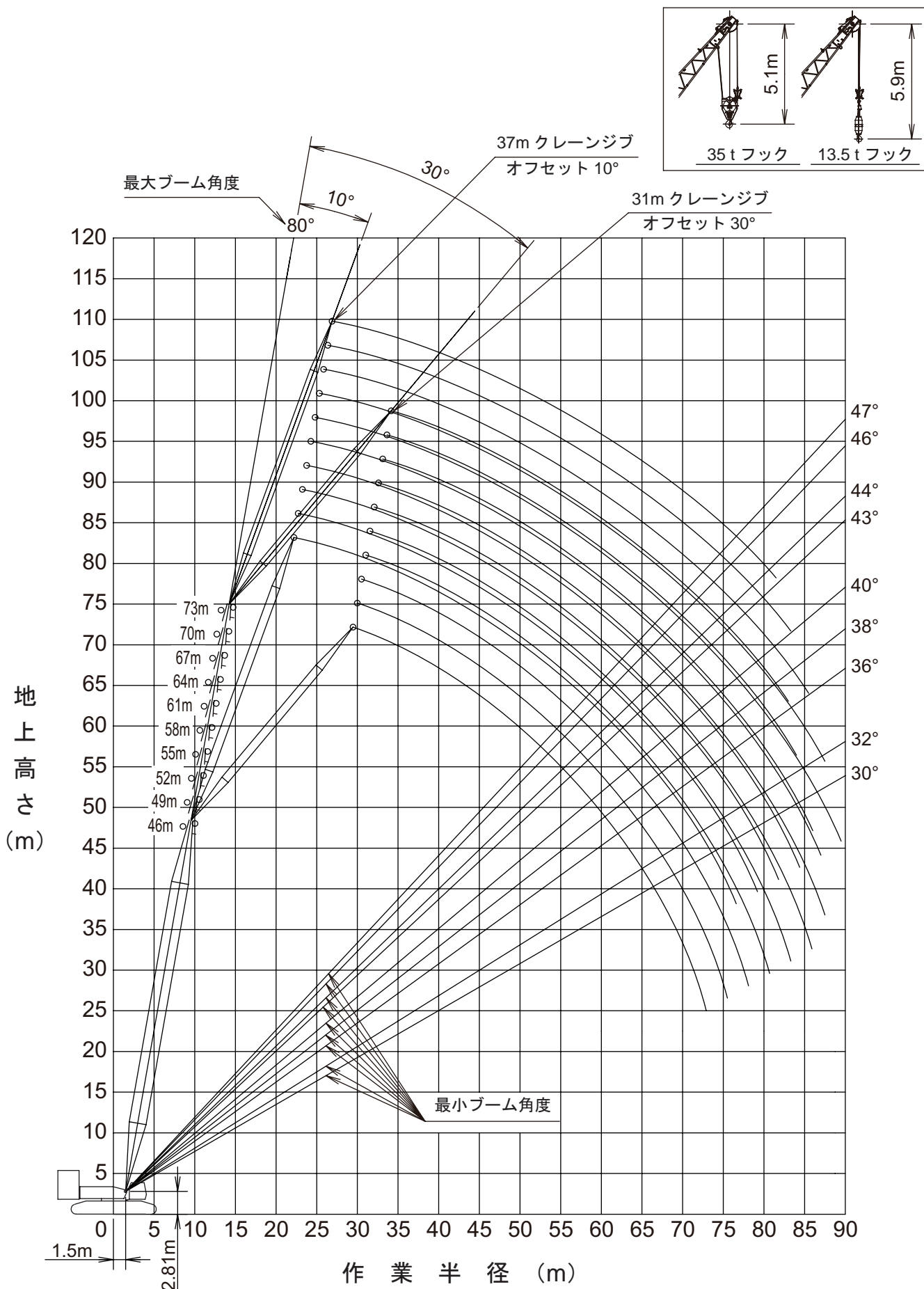

## 定格総荷重表

### ■主ブーム(クレーン専用ブーム)



作業半径 (m)	主ブーム長さ(m)										作業半径 (m)		
	16	19	22	25	28	31	34	37	40	43		46	
		5.6m x											
5	200.0	193.7t											5
6	189.8	189.6	6.1m x	6.6m x									6
7	164.1	163.9	181.1t	162.0t	7.2m x	7.7m x							7
8	144.5	144.3	163.5	162.0	151.0t	132.5t	8.3m x	8.8m x					8
9	129.0	128.8	143.9	143.5	143.3	132.1	128.4t	107.5t	9.4m x	9.9m x			9
10	116.5	116.3	128.4	128.0	127.8	125.0	125.0	106.9	103.2t	97.6t	10.5m x		10
12	90.7	90.6	115.8	115.5	115.2	114.8	114.6	103.8	100.0	97.2	88.6t		12
14	72.1	73.0	90.4	90.2	90.0	89.8	89.6	89.6	89.4	89.2	86.0		14
16	15.6m x	72.1	72.7	72.5	72.3	72.1	71.9	71.8	71.6	71.4	71.3		16
18	58.0t	61.0	60.7	60.5	60.2	60.1	60.0	60.1	59.9	59.9	59.5		18
20		52.4	52.4	52.1	51.8	51.4	51.3	51.5	51.4	51.5	51.2		20
22		18.2m x	45.7	45.3	45.6	44.7	44.7	44.8	44.8	44.9	44.6		22
24		51.6t	20.8m x	40.1	40.0	39.8	39.5	39.6	39.6	39.7	39.4		24
26			43.1t	23.4m x	35.4	35.5	35.6	35.4	35.4	35.4	35.1		26
28				36.8t	31.7	31.9	31.9	32.2	31.7	31.7	31.5		28
30						29.0	28.9	29.1	29.0	28.6	28.4		30
32						28.6m x	26.1	26.1	26.0	25.9	25.7		32
34						28.0t	31.2m x	23.8	23.7	23.6	23.4		34
36							24.7t	33.8m x	21.7	21.6	21.4		36
38								22.0t	19.9	19.8	19.6		38
40									36.4m x	18.3	18.1		40
42									19.6t	39.0m x	16.7		42
44										17.6t	41.6m x		44
											15.7t		44

1. 上表に示す定格総荷重は、水平堅土上の定置荷役における値で、転倒荷重の78%以内、および移動式クレーン構造規格で定める前方安定度1.15以上です。
2. 実際につり上げられる荷重は、上表の定格総荷重からフックなどのつり具一切の質量を差し引いた値です。
3. 口太線の値は強度に基づいています。
4. 作業半径とは、荷をついた状態での旋回中心からつり荷の重心までの水平距離です。
5. カウンタウエイトは、標準仕様(105.2t)です。
6. 表中の〇〇m x 〇〇t は、作業半径 m x 定格総荷重 t を示します。
7. 巻上ロープ掛数と定格総荷重の最大値は下表のとおりです。

フック 容量	フック 質量 (t)	定格総荷重の最大値(t)											
		16本掛	14本掛	12本掛	10本掛	8本掛	7本掛	6本掛	5本掛	4本掛	3本掛	2本掛	1本掛
200t	3.0	200	185	162	-	-	-	-	-	-	-	-	-
135t	2.6	-	-	-	135	108	94.5	81	67.5	54	40.5	27	-
80t	2.0	-	-	-	-	-	-	80	67.5	54	40.5	27	-
35t	1.07	-	-	-	-	-	-	-	-	-	35	27	-
13.5t	0.62	-	-	-	-	-	-	-	-	-	-	-	13.5

8. 16mブームは200tフックのみ、19mブームは80tフック以上の使用となります。

## ■主ブーム(クレーン専用ブーム)



作業半径 (m)	主ブーム長さ(m)										作業半径 (m)		
	49	52	55	58	61	64	67	70	73	76		79	
9	11.0m x 81.0t	11.6m x 75.5t											9
10			12.1m x 73.6t	12.7m x 65.9t	13.2m x 59.8t	13.8m x 52.9t							10
12							14.3m x 49.7t	14.8m x 43.8t	15.4m x 38.3t	15.9m x 33.7t			12
14											16.5m x 29.5t		14
16													16
18													18
20													20
22													22
24													24
26													26
28													28
30													30
32													32
34													34
36													36
38													38
40													40
42													42
44													44
46													46
48													48
50													50
52													52
54													54
56													56
58													58
60													60
62													62
64													64
66													66
68													68
70													70
72													72

・注記は、15 ページに記載されています。



■補助シーブ(クレーン専用ブーム)



作業半径 (m)	主ブーム長さ(m)											作業半径 (m)
	16	19	22	25	28	31	34	37	40	43	46	
5.9	13.5	6.4m x	6.9m x									5.9
6	13.5	13.5t	13.5t	7.5m x								6
7	13.5	13.5	13.5	13.5t		8.6m x						7
8	13.5	13.5	13.5	13.5	13.5	13.5t	9.1m x	9.7m x				8
9	13.5	13.5	13.5	13.5	13.5	13.5	13.5t	13.5t	10.2m x	10.8m x	11.3m x	9
10	13.5	13.5	13.5	13.5	13.5	13.5	13.5	13.5	13.5t	13.5t	13.5t	10
12	13.5	13.5	13.5	13.5	13.5	13.5	13.5	13.5	13.5	13.5	13.5	12
14	13.5	13.5	13.5	13.5	13.5	13.5	13.5	13.5	13.5	13.5	13.5	14
16	13.5	13.5	13.5	13.5	13.5	13.5	13.5	13.5	13.5	13.5	13.5	16
18	16.9m x	13.5	13.5	13.5	13.5	13.5	13.5	13.5	13.5	13.5	13.5	18
20	13.5t	19.5m x	13.5	13.5	13.5	13.5	13.5	13.5	13.5	13.5	13.5	20
22		13.5t	13.5	13.5	13.5	13.5	13.5	13.5	13.5	13.5	13.5	22
24				13.5	13.5	13.5	13.5	13.5	13.5	13.5	13.5	24
26				24.6m x	13.5	13.5	13.5	13.5	13.5	13.5	13.5	26
28				13.5t	27.2m x	13.5	13.5	13.5	13.5	13.5	13.5	28
30					13.5t	29.8m x	13.5	13.5	13.5	13.5	13.5	30
32						13.5t	13.5	13.5	13.5	13.5	13.5	32
34							32.4m x	13.5	13.5	13.5	13.5	34
36							13.5t	35.0m x	13.5	13.5	13.5	36
38								13.5t	37.6m x	13.5	13.5	38
40									13.5t	13.5	13.5	40
42										40.2m x	13.5	42
44										13.5t	42.8m x	44
46											13.5t	46

作業半径 (m)	主ブーム長さ(m)											作業半径 (m)
	49	52	55	58	61	64	67	70	73	76	79	
9	11.9m x											9
10	13.5t	12.4m x	13.0m x	13.5m x								10
12	13.5	13.5t	13.5t	13.5t	14.1m x	14.6m x	15.1m x	15.7m x				12
14	13.5	13.5	13.5	13.5	13.5t	13.5t	13.5t	13.5t	16.2m x	16.8m x	17.3m x	14
16	13.5	13.5	13.5	13.5	13.5	13.5	13.5	13.5	13.5t	13.5t	13.5t	16
18	13.5	13.5	13.5	13.5	13.5	13.5	13.5	13.5	13.5	13.5	13.5	18
20	13.5	13.5	13.5	13.5	13.5	13.5	13.5	13.5	13.5	13.5	13.5	20
22	13.5	13.5	13.5	13.5	13.5	13.5	13.5	13.5	13.5	13.5	13.5	22
24	13.5	13.5	13.5	13.5	13.5	13.5	13.5	13.5	13.5	13.5	13.5	24
26	13.5	13.5	13.5	13.5	13.5	13.5	13.5	13.5	13.5	13.5	13.5	26
28	13.5	13.5	13.5	13.5	13.5	13.5	13.5	13.5	13.5	13.5	13.5	28
30	13.5	13.5	13.5	13.5	13.5	13.5	13.5	13.5	13.5	13.5	13.5	30
32	13.5	13.5	13.5	13.5	13.5	13.5	13.5	13.5	13.5	13.5	13.5	32
34	13.5	13.5	13.5	13.5	13.5	13.5	13.5	13.5	13.5	13.5	13.5	34
36	13.5	13.5	13.5	13.5	13.5	13.5	13.5	13.5	13.5	13.5	13.4	36
38	13.5	13.5	13.5	13.5	13.5	13.5	13.5	13.5	13.5	13.5	12.4	38
40	13.5	13.5	13.5	13.5	13.5	13.5	13.5	13.5	13.5	12.8	11.5	40
42	13.5	13.5	13.5	13.5	13.5	13.5	13.5	13.5	13.4	11.9	10.6	42
44	13.5	13.5	13.5	13.4	13.1	12.9	12.7	12.5	12.3	11.1	9.8	44
46	45.4m x	12.8	12.6	12.4	12.1	11.9	11.7	11.4	11.3	10.2	9.0	46
48	13.5t	11.9	11.7	11.5	11.1	11.0	10.8	10.5	10.4	9.4	8.2	48
50			10.9	10.8	10.3	10.2	10.0	9.6	9.5	8.7	7.5	50
52			50.6m x	10.0	9.6	9.5	9.2	8.8	8.7	8.0	6.8	52
54			10.7t	53.2m x	8.9	8.7	8.4	8.1	8.0	7.3	6.2	54
56				9.5t	55.8m x	8.0	7.7	7.5	7.3	6.6	5.5	56
58					8.2t	7.4	7.1	6.8	6.7	6.0	4.9	58
60						58.4m x	6.5	6.3	6.1	5.4	4.3	60
62						7.2t	61.0m x	5.7	5.5	4.8	3.8	62
64							6.3t	63.6m x	4.9	4.2	3.2	64
66								5.3t	4.4	3.6	2.7	66
68									66.2m x	3.0	66.6m x	68
70									4.3t	68.8m x	2.5t	70
72										2.8t		72

1. 上表に示す定格総荷重は、水平堅土上の定置荷役における値で、転倒荷重の78%以内、および移動式クレーン構造規格で定める前方安定度1.15以上です。
2. 実際につり上げられる荷重は、上表の定格総荷重から「主フック+補助フック」などのつり具一切の質量を差し引いた値です。
3. □太線の値は強度に基づいています。
4. 作業半径とは、荷をついた状態での旋回中心からつり荷の重心までの水平距離です。
5. カウンタウイトは、標準仕様(105.2t)です。
6. 表中の○○m x ○○t は、作業半径 m x 定格総荷重 t を示します。
7. フック質量は下表のとおりです。

フック 容量	フック 質量 (t)
200t	3.0
135t	2.6
80t	2.0
35t	1.07
13.5t	0.62

■補助シーブ付き主ブーム(クレーン専用ブーム)



作業半径 (m)	主ブーム長さ(m)											作業半径 (m)
	16	19	22	25	28	31	34	37	40	43	46	
		5.6m x										
5	200.0	193.3t										5
6	189.4	189.2	6.1m x	6.6m x								6
7	163.7	163.5	180.4t	162.0t	7.2m x	7.7m x						7
8	144.1	143.9	163.1	162.0	150.3t	131.8t	8.3m x	8.8m x				8
9	128.6	128.4	143.5	143.0	142.8	131.4	127.7t	106.8t	9.4m x	9.9m x		9
10	116.1	115.9	128.0	127.5	127.3	124.3	124.3	106.2	102.4t	96.8t	10.5m x	10
12	90.3	90.2	115.4	115.0	114.7	114.3	114.1	103.1	99.2	96.4	87.8t	12
14	71.7	72.5	89.9	89.7	89.5	89.3	89.1	89.1	88.9	88.4	85.2	14
16	15.6m x	60.6	72.2	72.0	71.8	71.6	71.4	71.3	71.1	70.9	70.7	16
18	57.6t		60.2	60.0	59.7	59.6	59.5	59.6	59.4	59.4	58.9	18
20		18.2m x	51.9	51.6	51.3	50.9	50.8	51.0	50.9	51.0	50.6	20
22		51.2t	45.3	44.8	45.1	44.2	44.2	44.3	44.3	44.4	44.0	22
24			20.8m x	39.6	39.5	39.3	39.0	39.1	39.1	39.2	38.9	24
26			42.7t	36.4t	34.9	35.0	35.1	34.9	34.9	34.9	34.6	26
28					31.2	31.4	31.4	31.7	31.2	31.2	31.0	28
30						28.5	28.4	28.6	28.5	28.1	27.8	30
32						28.6m x	25.6	25.6	25.5	25.4	25.1	32
34						27.5t	31.2m x	23.3	23.2	23.1	22.9	34
36							24.2t	33.8m x	21.2	21.1	20.9	36
38								21.5t	19.4	19.3	19.1	38
40									36.4m x	17.8	17.6	40
42									19.1t	39.0m x	16.2	42
44										17.1t	41.6m x	44
											15.2t	44

作業半径 (m)	主ブーム長さ(m)											作業半径 (m)
	49	52	55	58	61	64	67	70	73	76	79	
9	11.0m x	11.6m x										9
10	80.2t	74.7t										10
12	77.2	74.2	12.1m x	12.7m x	13.2m x	13.8m x						12
14	70.3	69.9	72.8t	65.1t	59.0t	52.1t	14.3m x	14.8m x	15.4m x	15.9m x		14
16	58.6	58.1	68.2	63.1	57.7	51.9	48.9t	42.9t	37.4t	32.8t	16.5m x	16
18	50.3	49.9	57.6	57.5	54.3	49.6	46.9	42.0	37.0	32.8	28.6t	18
20	43.8	43.4	49.4	49.0	48.6	47.3	44.3	40.6	35.7	31.3	27.6	20
22	38.6	38.3	43.0	42.8	42.5	42.1	41.7	39.4	34.6	29.7	26.2	22
24	34.3	34.0	37.9	37.7	37.4	37.2	36.7	36.3	32.5	28.2	24.8	24
26	30.8	30.5	33.7	33.5	33.2	33.0	32.7	32.2	30.2	26.8	23.5	26
28	27.8	27.5	30.1	30.0	29.7	29.5	29.2	28.7	28.1	25.1	22.2	28
30	25.1	24.9	27.1	27.0	26.7	26.6	26.3	25.9	25.7	23.2	20.6	30
32	22.7	22.5	24.6	24.4	24.2	24.0	23.7	23.5	23.1	21.4	19.0	32
34	20.7	20.5	22.2	22.2	21.9	21.8	21.5	21.3	20.9	20.0	17.5	34
36	19.0	18.7	20.2	20.2	19.9	19.8	19.6	19.3	19.1	18.6	16.2	36
38	17.5	17.2	18.5	18.4	18.1	18.0	17.7	17.5	17.4	17.1	15.1	38
40	16.1	15.8	16.8	16.8	16.6	16.5	16.2	15.9	15.8	15.5	14.0	40
42	14.8	14.6	15.5	15.4	15.2	15.0	14.8	14.5	14.4	14.1	13.0	42
44	13.7	13.5	14.3	14.2	13.9	13.8	13.6	13.2	13.1	12.9	12.0	44
46	44.2m x	12.6	13.1	13.1	12.8	12.6	12.4	12.2	12.0	11.8	11.2	46
48	13.6t	46.8m x	12.3	12.1	11.8	11.6	11.4	11.2	11.0	10.7	10.4	48
50		12.2t	11.5	11.2	10.8	10.7	10.5	10.2	10.0	9.8	9.4	50
52			49.4m x	10.5	10.0	9.9	9.7	9.4	9.2	8.9	8.6	52
54			10.9t	9.7	9.3	9.2	9.0	8.6	8.5	8.1	7.8	54
56					8.7	8.5	8.2	7.9	7.7	7.5	7.1	56
58					54.6m x	7.8	7.5	7.2	7.1	6.7	6.4	58
60					8.6t	57.2m x	6.9	6.6	6.4	6.1	5.8	60
62						7.5t	59.7m x	6.0	5.8	5.5	5.2	62
64							6.5t	5.5	5.2	4.9	4.6	64
66								62.3m x	4.6	4.3	4.0	66
68								5.3t	64.9m x	3.8	3.5	68
70									4.4t	67.5m x	3.0	70
72										3.4t	2.5	72
74											70.1m x	74
											2.5t	74

- 上表に示す定格総荷重は、水平堅土上の定置荷役における値で、転倒荷重の78%以内、および移動式クレーン構造規格で定める前方安定度1.15以上です。
- 実際につり上げられる荷重は、上表の定格総荷重から「主フック+補フック」などのつり具一切の質量を差し引いた値です。
- 口太線の値は強度に基づいています。
- 作業半径とは、荷をつった状態での旋回中心からつり荷の重心までの水平距離です。
- カウンタウエイトは、標準仕様(105.2t)です。
- 表中の〇〇m x 〇〇t は、作業半径 m x 定格総荷重 t を示します。
- 巻上ロープ掛数と定格総荷重の最大値は下表のとおりです。

フック 容量	フック 質量 (t)	定格総荷重の最大値(t)											
		16本掛	14本掛	12本掛	10本掛	8本掛	7本掛	6本掛	5本掛	4本掛	3本掛	2本掛	1本掛
200t	3.0	200	185	162	-	-	-	-	-	-	-	-	-
135t	2.6	-	-	-	135	108	94.5	81	67.5	54	40.5	27	-
80t	2.0	-	-	-	-	-	-	80	67.5	54	40.5	27	-
35t	1.07	-	-	-	-	-	-	-	-	-	35	27	-
13.5t	0.62	-	-	-	-	-	-	-	-	-	-	-	13.5

8. 16mブームは、200tフック、135tフックのみの使用となります。

■クレーンジブ(クレーン専用ブーム・タワー併用ブーム共通)



ブーム長さ(m) ジブ長さ(m) オフセット角度(°) 作業半径(m)	46								ブーム長さ(m) ジブ長さ(m) オフセット角度(°) 作業半径(m)	
	13		19		25		31			37
	10	30	10	30	10	30	10	30	10	
14.6	27.0		16.7m x 19.7t							14.6
16	27.0	18.3m x 14.8t			19.1m x 13.1t					16
18	26.3						21.2m x 7.1t			18
20	25.3	14.5	18.8	22.6m x 10.5t	13.0				23.3m x 5.0t	20
22	24.3	14.2	18.2	10.5t	12.7					22
24	23.3	13.9	17.7	10.4	12.5	26.5m x 8.5t	7.0		5.0	24
26	22.3	13.6	17.1	10.2	12.3		6.8		4.9	26
28	21.4	13.3	16.6	9.9	12.1	8.4	6.7	30.4m x 5.3t	4.8	28
30	20.4	13.0	16.1	9.7	11.9	8.3	6.6		4.7	30
32	19.5	12.7	15.5	9.5	11.6	8.1	6.5	5.3	4.7	32
34	18.5	12.4	15.0	9.3	11.4	7.9	6.4	5.3	4.6	34
36	17.5	12.1	14.4	9.1	11.2	7.8	6.2	5.2	4.5	36
38	16.6	11.8	13.9	8.8	11.0	7.6	6.1	5.1	4.4	38
40	15.6	11.5	13.3	8.6	10.8	7.4	6.0	5.1	4.3	40
42	14.6	11.2	12.8	8.4	10.6	7.3	5.9	5.0	4.3	42
44	13.7	10.9	12.3	8.2	10.3	7.1	5.7	4.9	4.2	44
46	12.7	10.6	11.7	8.0	10.1	7.0	5.6	4.9	4.1	46
48	11.8	10.3	11.2	7.7	9.9	6.8	5.5	4.8	4.0	48
50	10.8	10.0	10.6	7.5	9.7	6.6	5.4	4.8	4.0	50
52	9.8	9.7	10.1	7.3	9.5	6.5	5.3	4.7	3.9	52
54	53.4m x 9.1t	9.4	9.6	7.1	9.2	6.3	5.1	4.6	3.8	54
56		54.1m x 9.3t	9.0	6.9	9.0	6.2	5.0	4.6	3.7	56
58	*54.1m x 8.7t		8.5	6.6	8.8	6.0	4.9	4.5	3.6	58
60		*54.9m x 9.3t	59.0m x 8.2t	6.4	8.6	5.8	4.8	4.4	3.6	60
62				60.9m x 6.3t	8.3	5.7	4.7	4.4	3.5	62
64			*59.7m x 7.9t		8.0	5.5	4.5	4.3	3.4	64
66					65.4m x 7.7t	5.3	4.4	4.2	3.3	66
68						66.9m x 5.2t	4.3	4.2	3.3	68
70							4.2	4.1	3.2	70
72							71.0m x 4.1t		3.1	72
74								72.9m x 4.1t	3.0	74
76									2.9	76
78									76.6m x 2.8t	78
80										80

1. 上表に示す定格総荷重は、水平堅土上の定置荷役における値で、転倒荷重の78%以内、および移動式クレーン構造規格で定める前方安定度1.15以上です。
2. 実際につり上げられる荷重は、上表の定格総荷重から「主フック+補フック」などのつり具一切の質量を差し引いた値です。
3. □太線の値は強度に基づいています。
4. 作業半径とは、荷をついた状態での旋回中心からつり荷の重心までの水平距離です。
5. カウンタウエイトは、標準仕様(105.2t)です。
6. 表中の○○m x ○○t は、作業半径 m x 定格総荷重 t を示します。
7. 13mジブ・19mジブオフセット角10°は、2本掛の値を示します。ただし\*印の作業半径は、1本掛での最大作業半径を示します。他は、1本掛の値を示します。

フック 容量	フック 質量(t)
80t	2.0
35t	1.07
13.5t	0.62

■クレーンジブ(クレーン専用ブーム・タワー併用ブーム共通)



ブーム長さ(m)	49								ブーム長さ(m)	
	13		19		25		31			37
ジブ長さ(m)	10		30		10		30		10	
オフセット角度(°)	10		30		10		30		10	
作業半径(m)	10		30		10		30		10	
12	15.2m x								12	
14	27.0t								14	
16		18.8m x	17.3m x		19.6m x				16	
18	26.5	14.8t	19.4		13.1t				18	
20	25.6	14.6	18.9	23.2m x	13.0		21.7m x		20	
22	24.7	14.3	18.4	10.5t	12.8		7.1t	23.8m x	22	
24	23.8	14.0	17.9	10.5	12.6	27.1m x	7.0	5.0t	24	
26	22.9	13.7	17.4	10.3	12.4	8.5t	6.9	5.0	26	
28	22.0	13.5	16.9	10.0	12.2	8.5	6.8	4.9	28	
30	21.1	13.2	16.4	9.8	12.0	8.3	6.6	31.0m x	30	
32	20.1	12.9	15.8	9.6	11.8	8.2	6.5	5.3t	32	
34	19.2	12.6	15.3	9.4	11.6	8.0	6.4	5.3	34	
36	18.3	12.3	14.8	9.2	11.4	7.9	6.3	5.2	36	
38	17.5	12.0	14.3	9.0	11.1	7.7	6.2	5.2	38	
40	16.8	11.7	13.8	8.8	10.9	7.6	6.1	5.1	40	
42	15.5	11.5	13.3	8.6	10.7	7.4	5.9	5.0	42	
44	14.3	11.2	12.8	8.4	10.5	7.2	5.8	5.0	44	
46	13.2	10.9	12.3	8.2	10.3	7.1	5.7	4.9	46	
48	12.4	10.6	11.7	8.0	10.1	6.9	5.6	4.9	48	
50	11.6	10.3	11.2	7.8	9.9	6.8	5.5	4.8	50	
52	10.8	10.0	10.5	7.5	9.7	6.6	5.4	4.7	52	
54	10.2	9.4	9.9	7.3	9.5	6.5	5.3	4.7	54	
56	9.3	8.9	9.2	7.1	9.3	6.3	5.1	4.6	56	
58	*56.7m x	56.7m x	8.6	6.9	9.1	6.2	5.0	4.6	58	
60	9.1t	8.7t	8.1	6.7	8.9	6.0	4.9	4.5	60	
62		*57.5m x	61.6m x	6.5	8.5	5.9	4.8	4.4	62	
64		8.5t	7.7t	63.5m x	8.1	5.7	4.7	4.4	64	
66			*62.3m x	6.3t	7.6	5.6	4.6	4.3	66	
68			7.6t		7.0	5.4	4.4	4.3	68	
70						69.5m x	4.3	4.2	70	
72						5.2t	4.2	4.1	72	
74							73.6m x	4.0	74	
76							4.1t	75.5m x	76	
78								3.9t	78	
80									79.2m x	80
82									2.8t	82

・注記は、19 ページに記載されています。

■クレーンジブ(クレーン専用ブーム・タワー併用ブーム共通)



ブーム長さ(m) ジブ長さ(m) オフセット角度(°) 作業半径(m)	52								ブーム長さ(m) ジブ長さ(m) オフセット角度(°) 作業半径(m)	
	13		19		25		31			37
	10	30	10	30	10	30	10	30	10	
12	15.7m x 27.0t		17.8m x 19.8t							12
14	27.0		19.8t							14
16	27.0	19.4m x 14.7t	19.8t							16
18	26.9	14.8t	19.6		20.2m x 13.0t					18
20	26.0	14.7	19.1	23.7m x 10.5t			22.3m x 7.1t			20
22	25.1	14.4	18.6	10.5t	12.9			24.4m x 5.0t		22
24	24.2	14.1	18.1	10.5	12.7	27.6m x 8.5t	7.0			24
26	23.3	13.9	17.6	10.3	12.5		6.9			26
28	22.5	13.6	17.1	10.1	12.3	8.5	6.8	31.5m x 5.4t	4.9	28
30	21.7	13.3	16.6	9.9	12.1	8.4	6.7		4.8	30
32	20.9	13.1	16.1	9.7	11.9	8.2	6.6	5.4	4.7	32
34	20.1	12.8	15.7	9.5	11.7	8.1	6.5	5.3	4.7	34
36	19.2	12.5	15.2	9.3	11.5	7.9	6.4	5.3	4.6	36
38	17.7	12.3	14.7	9.1	11.3	7.8	6.3	5.2	4.5	38
40	16.3	12.0	14.2	8.9	11.1	7.6	6.1	5.1	4.4	40
42	15.1	11.7	13.7	8.7	10.9	7.5	6.0	5.1	4.4	42
44	14.0	11.4	13.2	8.5	10.7	7.3	5.9	5.0	4.3	44
46	13.0	11.2	12.7	8.3	10.5	7.2	5.8	5.0	4.2	46
48	12.0	10.9	12.2	8.1	10.3	7.1	5.7	4.9	4.1	48
50	11.1	10.6	11.6	7.9	10.1	6.9	5.6	4.8	4.1	50
52	10.4	10.2	10.8	7.7	9.9	6.8	5.5	4.8	4.0	52
54	9.8	9.8	10.0	7.5	9.7	6.6	5.4	4.7	3.9	54
56	9.2	9.2	9.4	7.4	9.5	6.5	5.2	4.7	3.9	56
58	8.6	8.6	8.8	7.2	9.2	6.3	5.1	4.6	3.8	58
60	58.6m x 8.1t	59.3m x 8.0t	8.3	7.0	8.7	6.2	5.0	4.6	3.7	60
62			7.7	6.8	8.2	6.0	4.9	4.5	3.6	62
64	*59.3m x 8.0t	*60.1m x 7.6t	7.2	6.6	7.7	5.9	4.8	4.4	3.6	64
66			64.2m x 7.1t	6.4	7.2	5.7	4.7	4.4	3.5	66
68				66.1m x 6.4t	6.7	5.6	4.6	4.3	3.4	68
70			*64.9m x 6.9t	6.4t	6.2	5.4	4.5	4.3	3.3	70
72					70.6m x 6.1t	5.2	4.4	4.2	3.3	72
74						72.1m x 5.2t	4.2	4.1	3.2	74
76							4.0	4.1	3.1	76
78							76.2m x 3.9t	4.1	3.1	78
80								78.1m x 4.1t	3.0	80
82									81.8m x 2.9t	82
84										84

・注記は、19 ページに記載されています。

■クレーンジブ(クレーン専用ブーム・タワー併用ブーム共通)



		(単位 t)								
ブーム長さ(m)	13		19		25		31		37	ブーム長さ(m)
ジブ長さ(m)	13		19		25		31		37	ジブ長さ(m)
オフセット角度(°)	10	30	10	30	10	30	10	30	10	オフセット角度(°)
作業半径(m)	13		19		25		31		37	作業半径(m)
14	16.3m x									14
16	27.0t									16
18	27.0	19.9m x	18.4m x							18
20	26.2	14.8t	19.7t		20.7m x					20
22	25.4	14.8	19.3		13.1t		22.8m x			22
24	25.4	14.5	18.8	24.3m x	12.9		7.1t		24.9m x	24
26	24.6	14.3	18.3	10.5t	12.7		7.0		5.0t	26
28	23.8	14.0	17.8	10.4	12.5	28.2m x	7.0		5.0	28
30	23.0	13.7	17.4	10.2	12.4	8.5t	6.8		4.9	30
32	22.2	13.5	16.9	10.0	12.2	8.4	6.7	32.1m x	4.8	32
34	21.4	13.2	16.4	9.8	12.0	8.3	6.6	5.3t	4.8	34
36	20.6	13.0	16.0	9.6	11.8	8.1	6.5	5.3	4.7	36
38	19.0	12.7	15.6	9.4	11.6	8.0	6.4	5.3	4.6	38
40	17.5	12.5	15.2	9.3	11.4	7.9	6.3	5.2	4.5	40
42	16.1	12.2	14.8	9.1	11.2	7.7	6.2	5.2	4.5	42
44	14.9	11.9	14.4	8.9	11.0	7.6	6.1	5.1	4.4	44
46	13.8	11.7	14.0	8.7	10.8	7.4	6.0	5.1	4.3	46
48	12.8	11.4	13.0	8.5	10.6	7.3	5.9	5.0	4.3	48
50	11.9	11.2	12.3	8.3	10.4	7.2	5.8	4.9	4.2	50
52	11.0	10.9	11.4	8.1	10.2	7.0	5.7	4.9	4.1	52
54	10.2	10.5	10.6	7.9	10.0	6.9	5.6	4.8	4.1	54
56	9.5	9.7	9.9	7.7	9.9	6.7	5.5	4.8	4.0	56
58	8.8	9.0	9.2	7.6	9.6	6.6	5.3	4.7	3.9	58
60	8.2	8.4	8.6	7.4	9.1	6.5	5.2	4.7	3.8	60
62	7.6	7.7	8.0	7.2	8.5	6.3	5.1	4.6	3.8	62
64	61.2m x	61.9m x	7.4	7.0	8.0	6.2	5.0	4.6	3.7	64
66	7.3t	7.2t	6.9	6.9	7.5	6.0	4.9	4.5	3.6	66
68	*61.9m x	*62.7m x	6.5	6.6	7.0	5.9	4.8	4.4	3.6	68
70	7.1t	6.9t	66.8m x	6.2	6.5	5.8	4.7	4.4	3.5	70
72			6.3t	68.7m x	6.1	5.6	4.6	4.3	3.4	72
74			*67.5m x	6.0t	5.7	5.3	4.5	4.3	3.4	74
76			6.1t		73.2m x	4.7	4.4	4.2	3.3	76
78					5.4t	74.7m x	4.3	4.2	3.2	78
80						4.5t	4.2	4.1	3.1	80
82							78.8m x	3.9	3.1	82
84							4.1t	80.7m x	3.0	84
86								3.8t	3.0	86
88									84.4m x	88
									2.9t	

・注記は、19 ページに記載されています。

■クレーンジブ(クレーン専用ブーム・タワー併用ブーム共通)



ブーム長さ(m) ジブ長さ(m) オフセット角度(°) 作業半径(m)	58								ブーム長さ(m) ジブ長さ(m) オフセット角度(°) 作業半径(m)	
	13		19		25		31			37
	10	30	10	30	10	30	10	30	10	
14	16.8m x 27.0t									14
16			18.9m x 19.7t							16
18	27.0	20.5m x 14.8t			21.3m x 13.1t					18
20	26.6	14.8t	19.4				23.4m x 7.1t			20
22	25.8	14.6	18.9	24.8m x 10.5t	13.0				25.5m x 5.0t	22
24	25.0	14.4	18.5	10.4	12.6		7.1		5.0	24
26	24.2	14.1	18.0	10.4	12.6	28.7m x 8.5t	7.0		5.0	26
28	23.4	13.9	17.6	10.3	12.4		6.9		4.9	28
30	22.6	13.6	17.1	10.1	12.2	8.5	6.8	32.6m x 5.4t	4.8	30
32	21.8	13.4	16.7	9.9	12.1	8.3	6.7	5.4	4.8	32
34	20.6	13.1	16.2	9.7	11.9	8.2	6.6	5.4	4.7	34
36	18.9	12.9	15.8	9.5	11.7	8.1	6.5	5.3	4.6	36
38	17.3	12.6	15.3	9.4	11.5	7.9	6.4	5.2	4.6	38
40	15.9	12.4	14.9	9.2	11.3	7.8	6.3	5.2	4.5	40
42	14.7	12.2	14.3	9.0	11.1	7.7	6.2	5.1	4.4	42
44	13.6	11.9	13.6	8.8	11.0	7.5	6.1	5.1	4.4	44
46	12.6	11.7	13.0	8.6	10.8	7.4	6.0	5.0	4.3	46
48	11.7	11.4	12.1	8.5	10.6	7.3	5.9	5.0	4.2	48
50	10.8	11.1	11.2	8.3	10.4	7.1	5.8	4.9	4.2	50
52	10.0	10.3	10.4	8.1	10.2	7.0	5.6	4.9	4.1	52
54	9.3	9.5	9.7	7.9	10.0	6.9	5.5	4.8	4.0	54
56	8.6	8.8	9.0	7.7	9.6	6.7	5.4	4.8	4.0	56
58	8.0	8.2	8.3	7.6	8.9	6.6	5.3	4.7	3.9	58
60	7.4	7.5	7.7	7.4	8.3	6.5	5.2	4.7	3.8	60
62	6.8	7.0	7.2	7.2	7.8	6.3	5.1	4.6	3.8	62
64	63.8m x 6.4t	6.4	6.7	7.0	7.2	6.2	5.0	4.5	3.7	64
66	6.4t	64.5m x 6.3t	6.2	6.6	6.7	6.1	4.9	4.5	3.6	66
68	*64.5m x 6.2t	*65.3m x 6.1t	69.4m x 5.4t	6.1	6.3	5.9	4.8	4.4	3.6	68
70			71.3m x 5.2t	5.6	5.9	5.7	4.7	4.4	3.5	70
72					5.5	5.5	4.6	4.3	3.4	72
74			*70.1m x 5.2t		5.1	5.2	4.5	4.3	3.4	74
76					75.8m x 4.7t	4.8	4.4	4.2	3.3	76
78						77.3m x 4.5t	4.3	4.2	3.2	78
80							4.2	4.2	3.2	80
82							81.4m x 3.9t	4.0	3.1	82
84								83.3m x 3.7t	3.0	84
86									2.9	86
88									87.0m x 2.5t	88
90										90

・注記は、19 ページに記載されています。

## ■クレーンジブ(クレーン専用ブーム・タワー併用ブーム共通)



ブーム長さ(m)		61								ブーム長さ(m)	
ジブ長さ(m)		13		19		25		31		37	
オフセット角度(°)	作業半径(m)	10	30	10	30	10	30	10	30	10	オフセット角度(°)
作業半径(m)										作業半径(m)	
14	17.4m x										14
16	27.0t			19.5m x							16
18	27.0	21.0m x		19.7t		21.8m x					18
20	26.6	14.7t		19.5		13.1t		23.9m x			20
22	25.6	14.6		19.0	25.4m x	13.0		7.1t			22
24	24.6	14.3		18.5	10.5t	12.9		7.1			24
26	23.6	14.0		18.0	10.5	12.7	29.3m x	7.0		5.0	26
28	22.7	13.7		17.6	10.3	12.5	8.5t	6.9		4.9	28
30	21.8	13.4		17.1	10.2	12.3	8.5	6.8	33.2m x	4.9	30
32	20.9	13.1		16.6	10.0	12.1	8.4	6.7	5.4t	4.8	32
34	20.0	12.8		16.1	9.8	12.0	8.3	6.6	5.4	4.7	34
36	18.5	12.5		15.6	9.6	11.8	8.1	6.5	5.3	4.7	36
38	16.9	12.2		15.2	9.5	11.6	8.0	6.4	5.3	4.6	38
40	15.6	11.9		14.7	9.3	11.4	7.9	6.3	5.2	4.5	40
42	14.3	11.6		14.1	9.1	11.3	7.7	6.2	5.2	4.5	42
44	13.2	11.3		13.6	9.0	11.1	7.6	6.1	5.1	4.4	44
46	12.2	11.0		12.6	8.8	10.9	7.5	6.0	5.1	4.4	46
48	11.3	10.7		11.7	8.6	10.7	7.4	5.9	5.0	4.3	48
50	10.4	10.4		10.9	8.4	10.5	7.2	5.8	5.0	4.2	50
52	9.6	9.9		10.1	8.3	10.3	7.1	5.7	4.9	4.2	52
54	8.9	9.2		9.3	8.1	9.9	7.0	5.6	4.9	4.1	54
56	8.2	8.5		8.6	7.9	9.2	6.8	5.5	4.8	4.0	56
58	7.6	7.8		8.0	7.7	8.6	6.7	5.4	4.8	4.0	58
60	7.0	7.2		7.4	7.5	8.0	6.6	5.3	4.7	3.9	60
62	6.5	6.6		6.8	7.2	7.4	6.5	5.2	4.6	3.8	62
64	6.0	6.0		6.3	6.7	6.9	6.3	5.1	4.6	3.8	64
66	5.4	5.5		5.8	6.2	6.4	6.2	5.0	4.5	3.7	66
68	66.4m x	67.1m x		5.4	5.7	5.9	6.0	4.9	4.5	3.6	68
70	5.3t	5.2t		4.9	5.2	5.5	5.8	4.8	4.4	3.6	70
72	*67.1m x	*67.9m x		4.5	4.8	5.0	5.3	4.7	4.4	3.5	72
74	5.1t	5.0t		*72.7m x	73.9m x	4.6	4.8	4.6	4.3	3.4	74
76				4.4t	4.3t	4.3	4.4	4.5	4.3	3.4	76
78						3.9	4.0	4.1	4.2	3.3	78
80						78.4m x	79.9m x	3.8	4.0	3.2	80
82						3.8t	3.6t	3.5	3.7	3.1	82
84								3.2	3.3	3.1	84
86									85.9m x	3.0	86
88									2.9t	2.8	88
90										89.5m x	90
92										2.5t	92

・注記は、19 ページに記載されています。



■クレーンジブ(クレーン専用ブーム・タワー併用ブーム共通)



ブーム長さ(m)	64								ブーム長さ(m)	
	13		19		25		31			37
ジブ長さ(m)	10	30	10	30	10	30	10	30	10	ジブ長さ(m)
オフセット角度(°)										
作業半径(m)										
14	17.9m x									14
16	25.6t									16
18	25.6	21.6m x								18
20	24.8	14.7t	19.6		22.3m x					20
22	24.0	14.7	19.0	25.9m x	13.1t		24.4m x			22
24	23.1	14.3	18.4	10.6t	12.9		7.1t		26.5m x	24
26	22.2	14.0	17.8	10.6	12.7	29.8m x	7.0		5.0t	26
28	21.4	13.7	17.2	10.4	12.6	8.5t	7.0		5.0	28
30	20.6	13.4	16.6	10.2	12.4	8.5	6.9	33.7m x	4.9	30
32	19.8	13.0	16.0	10.1	12.2	8.4	6.8	5.4t	4.8	32
34	19.0	12.7	15.4	9.9	12.1	8.3	6.7	5.4	4.8	34
36	18.2	12.4	14.7	9.7	11.9	8.2	6.6	5.3	4.7	36
38	16.8	12.0	14.1	9.6	11.7	8.1	6.5	5.3	4.6	38
40	15.4	11.7	13.5	9.4	11.5	7.9	6.4	5.2	4.6	40
42	14.2	11.4	12.9	9.2	11.4	7.8	6.3	5.2	4.5	42
44	13.1	11.1	12.3	9.1	11.2	7.7	6.2	5.1	4.5	44
46	12.1	10.7	11.7	8.9	11.0	7.6	6.1	5.1	4.4	46
48	11.2	10.4	11.1	8.7	10.9	7.4	6.0	5.0	4.3	48
50	10.3	10.1	10.5	8.6	10.7	7.3	5.9	5.0	4.3	50
52	9.5	9.8	9.9	8.4	10.6	7.2	5.8	4.9	4.2	52
54	8.8	9.1	9.2	8.2	9.8	7.1	5.7	4.9	4.1	54
56	8.1	8.3	8.5	8.1	9.1	6.9	5.6	4.8	4.1	56
58	7.4	7.6	7.8	7.9	8.5	6.8	5.5	4.8	4.0	58
60	6.8	7.0	7.2	7.6	7.9	6.7	5.4	4.7	3.9	60
62	6.3	6.4	6.6	7.2	7.3	6.6	5.3	4.7	3.9	62
64	5.7	5.8	6.1	6.6	6.7	6.4	5.2	4.6	3.8	64
66	5.3	5.3	5.6	6.0	6.2	6.3	5.1	4.6	3.8	66
68	4.8	4.8	5.1	5.5	5.7	6.1	5.0	4.5	3.7	68
70	69.0m x	69.7m x	4.7	5.1	5.2	5.6	4.9	4.5	3.6	70
72	4.5t	4.3t	4.3	4.6	4.8	5.1	4.8	4.4	3.6	72
74	*69.7m x	*70.5m x	3.9	4.1	4.4	4.7	4.7	4.4	3.5	74
76	4.4t	4.1t	74.6m x	3.6	4.0	4.3	4.3	4.4	3.4	76
78			3.7t	76.5m x	3.7	3.8	3.9	4.3	3.4	78
80			*75.3m x	3.5t	3.3	3.5	3.6	3.9	3.3	80
82			3.6t		81.0m x	3.0	3.2	3.5	3.3	82
84					3.0t	82.5m x	2.9	3.1	3.1	84
86						2.9t	2.5	2.8	2.8	86
88								87.5m x	87.5m x	88
90								2.5t	2.5t	90

・注記は、19 ページに記載されています。

■クレーンジブ(クレーン専用ブーム・タワー併用ブーム共通)



ブーム長さ(m)	67								ブーム長さ(m)
	13		19		25		31		
ジブ長さ(m)	10		30		10		30		10
オフセット角度(°)	10		30		10		30		10
作業半径(m)	10		30		10		30		10
16	18.5m x								16
18	24.9t								18
20	24.2								20
22	23.4	22.1m x			22.9m x				22
24	22.6	14.7t	20.6m x		13.1t		25.0m x		24
26	21.7	14.3	19.6t		13.0		7.1t		26
28	20.9	13.9	18.5	26.5m x	12.8		7.0	27.1m x	28
30	20.1	13.5	17.9	10.5t	12.6	30.4m x	6.9	5.0t	30
32	19.3	13.1	16.7	10.3	12.5	8.6t	6.8	4.9	32
34	18.5	12.7	16.1	10.1	12.3	8.5	6.7	34.3m x	34
36	17.7	12.3	15.5	10.0	12.1	8.3	6.6	5.4t	36
38	16.6	12.0	14.9	9.8	12.0	8.2	6.5	5.4	38
40	15.2	11.6	14.3	9.6	11.8	8.1	6.4	5.3	40
42	14.0	11.2	13.7	9.5	11.6	8.0	6.3	5.2	42
44	12.8	10.8	13.0	9.3	11.5	7.9	6.2	5.2	44
46	11.8	10.4	12.5	9.2	11.3	7.7	6.1	5.2	46
48	10.9	10.0	11.9	9.0	11.1	7.6	6.1	5.1	48
50	10.1	9.6	11.3	8.9	11.0	7.5	6.0	5.1	50
52	9.3	9.2	10.5	8.7	10.7	7.4	5.9	5.0	52
54	8.5	8.8	9.7	8.5	10.3	7.3	5.8	4.9	54
56	7.8	8.4	8.9	8.4	9.6	7.2	5.7	4.8	56
58	7.1	8.0	8.2	8.2	8.9	7.0	5.6	4.8	58
60	6.5	7.3	7.5	7.9	8.2	6.9	5.5	4.7	60
62	5.9	6.7	6.9	7.5	7.5	6.8	5.4	4.7	62
64	5.4	6.1	6.3	6.9	6.9	6.7	5.3	4.6	64
66	4.9	5.5	5.8	6.4	6.4	6.6	5.2	4.6	66
68	4.5	5.0	5.3	5.8	5.9	6.4	5.1	4.6	68
70	4.0	4.5	4.8	5.3	5.4	5.9	5.0	4.5	70
72	71.6m x	4.1	4.4	4.8	4.9	5.4	4.8	4.5	72
74	3.7t	3.6	3.9	4.4	4.5	4.9	4.7	4.5	74
76	*72.3m x	3.2	3.6	4.1	4.4	4.4	4.6	4.4	76
78	3.5t	3.5t	3.2	3.4	3.7	4.0	4.5	4.4	78
80		*73.1m x	3.0	3.4	3.4	3.6	4.0	4.0	80
82		3.4t	2.9t	79.1m x	3.0	3.2	3.2	3.6	82
84			*77.9m x	2.7t	2.7	2.8	2.9	3.2	84
86			2.8t		83.3m x	83.5m x	2.5	2.9	86
88					2.5t	2.5t	2.5	85.5m x	88
							2.5	2.5t	

・注記は、19 ページに記載されています。

■クレーンジブ(クレーン専用ブーム・タワー併用ブーム共通)



ブーム長さ(m)	70								ブーム長さ(m)
	13		19		25		31		
ジブ長さ(m)	10		30		10		30		10
オフセット角度(°)	10		30		10		30		10
作業半径(m)	10		30		10		30		10
16	19.0m x								16
18	22.5t								18
20	22.1	22.7m x	21.1m x		23.4m x				20
22	21.4	14.6t	18.1t		13.1t		25.5m x		22
24	20.6	14.3	17.3		13.0		7.1t	27.6m x	24
26	19.9	13.8	16.7	27.0m x	10.5t	12.8	7.1	5.0t	26
28	19.2	13.3	16.1	10.5	12.7	30.9m x	7.0	5.0	28
30	18.5	12.8	15.6	10.3	12.5	8.5t	6.9	4.9	30
32	17.8	12.3	15.0	10.2	12.4	8.5	6.8	34.8m x	32
34	17.1	11.8	14.4	10.0	12.2	8.4	6.7	5.4t	34
36	16.4	11.3	13.9	9.9	12.0	8.3	6.7	5.4	36
38	15.7	10.8	13.3	9.7	11.9	8.2	6.6	5.3	38
40	14.8	10.3	12.7	9.6	11.7	8.0	6.5	5.3	40
42	13.6	9.8	12.1	9.4	11.6	7.9	6.4	5.2	42
44	12.5	9.4	11.6	9.3	11.4	7.8	6.3	5.2	44
46	11.5	8.9	11.0	9.1	11.2	7.7	6.2	5.1	46
48	10.5	8.4	10.3	9.0	11.0	7.6	6.1	5.1	48
50	9.6	7.9	9.6	8.8	10.8	7.5	6.0	5.0	50
52	8.8	7.4	9.0	8.7	10.0	7.4	5.9	5.0	52
54	8.0	6.9	8.5	8.5	9.2	7.2	5.8	5.0	54
56	7.3	6.4	7.7	8.3	8.5	7.1	5.8	4.9	56
58	6.6	5.9	7.0	7.9	7.8	7.0	5.7	4.9	58
60	6.0	5.4	6.4	7.2	7.1	6.9	5.6	4.8	60
62	5.4	4.9	5.8	6.6	6.5	6.8	5.5	4.8	62
64	4.9	4.4	5.3	6.0	6.0	6.6	5.4	4.7	64
66	4.4	3.9	4.8	5.4	5.4	6.0	5.3	4.7	66
68	4.0	3.4	4.3	4.9	4.9	5.5	5.2	4.6	68
70	3.5	2.9	3.9	4.4	4.5	5.0	4.8	4.6	70
72	3.1	71.6m x	3.5	4.0	4.1	4.5	4.3	4.6	72
74	2.8	2.5t	3.1	3.5	3.7	4.0	3.9	4.5	74
76	74.2m x		2.7	3.0	3.3	3.6	3.5	4.1	76
78	2.7t		77.0m x	2.6	2.9	3.2	3.2	3.7	78
80	*74.9m x		2.5t	78.7m x	2.5	2.8	2.8	3.3	80
82	2.6t			2.5t		81.5m x	81.5m x	2.9	82
84						2.5t	2.5t	2.5	84
86								83.3m x	86
								2.5t	

・注記は、19 ページに記載されています。

## ■クレーンジブ(クレーン専用ブーム・タワー併用ブーム共通)



ブーム長さ(m)	73								ブーム長さ(m)
	13		19		25		31		
ジブ長さ(m)	10		30		10		30		10
オフセット角度(°)	10		30		10		30		10
作業半径(m)	19.5m x 19.6t		21.6m x 17.8t		27.6m x 13.1t		26.1m x 7.1t		28.2m x 5.0t
16									16
18									18
20									20
22									22
24									24
26									26
28									28
30									30
32									32
34									34
36									36
38									38
40									40
42									42
44									44
46									46
48									48
50									50
52									52
54									54
56									56
58									58
60									60
62									62
64									64
66									66
68									68
70									70
72									72
74									74
76									76
78									78
80									80
82									82
84									84
86									86

・注記は、19 ページに記載されています。

■クレーンジブ付き主ブーム(クレーン専用ブーム・タワー併用ブーム共通)



ブーム長さ(m) ジブ長さ(m) オフセット角度(°) 作業半径(m)	46								ブーム長さ(m) ジブ長さ(m) オフセット角度(°) 作業半径(m)	
	13		19		25		31		37	
	10	30	10	30	10	30	10	30	10	
10.5	77.3	77.2	76.2	76.1	74.9	74.8	73.6	73.5	72.2	10.5
12	74.8	74.7	73.8	73.7	72.5	72.4	71.2	71.1	69.8	12
14	68.5	68.0	67.7	66.9	67.3	66.4	66.5	65.2	65.6	14
16	57.4	57.0	56.6	55.9	56.2	55.4	55.4	54.4	54.6	16
18	49.0	48.6	48.3	47.6	47.9	47.2	47.1	46.2	46.2	18
20	42.5	42.1	41.7	41.2	41.3	40.8	40.6	39.8	39.7	20
22	37.2	36.9	36.5	36.1	36.1	35.6	35.4	34.7	34.5	22
24	32.9	32.7	32.2	31.8	31.8	31.4	31.1	30.5	30.3	24
26	29.3	29.1	28.5	28.2	28.2	27.8	27.4	26.9	26.6	26
28	26.1	25.9	25.4	25.1	25.0	24.7	24.3	23.8	23.5	28
30	23.5	23.3	22.7	22.5	22.3	22.1	21.6	21.2	20.8	30
32	21.2	21.0	20.4	20.2	20.0	19.8	19.3	19.0	18.5	32
34	19.2	19.0	18.5	18.3	18.0	17.8	17.3	17.1	16.6	34
36	17.4	17.3	16.7	16.6	16.3	16.1	15.6	15.4	14.8	36
38	15.9	15.8	15.2	15.1	14.8	14.6	14.1	13.9	13.3	38
40	14.5	14.4	13.7	13.6	13.4	13.3	12.7	12.6	12.0	40
42	41.6m x 13.4t	41.6m x 13.4t	41.6m x 12.6t	41.6m x 12.5t	41.6m x 12.4t	41.6m x 12.4t	41.6m x 11.7t	41.6m x 11.7t	41.6m x 10.8t	42
44										44

ブーム長さ(m) ジブ長さ(m) オフセット角度(°) 作業半径(m)	49								ブーム長さ(m) ジブ長さ(m) オフセット角度(°) 作業半径(m)	
	13		19		25		31		37	
	10	30	10	30	10	30	10	30	10	
8	11.0m x 67.5t	11.0m x 67.5t	11.0m x 67.5t	11.0m x 67.5t	11.0m x 67.5t	11.0m x 67.4t	11.0m x 66.2t	11.0m x 66.1t	11.0m x 64.8t	8
10	67.5	67.5	67.3	67.2	66.0	65.9	64.8	64.7	63.4	10
12	67.5	67.5	67.3	67.2	66.0	65.9	64.8	64.7	63.4	12
14	65.4	65.3	64.4	64.3	63.1	63.0	61.9	61.8	60.6	14
16	57.1	56.7	56.3	55.6	56.0	55.2	55.2	54.1	54.4	16
18	48.8	48.4	48.0	47.4	47.7	47.0	46.9	46.0	46.1	18
20	42.3	42.0	41.6	41.0	41.2	40.6	40.5	39.6	39.6	20
22	37.1	36.8	36.4	35.9	36.0	35.5	35.3	34.6	34.5	22
24	32.8	32.5	32.1	31.7	31.7	31.3	31.0	30.4	30.2	24
26	29.2	29.0	28.5	28.2	28.2	27.8	27.4	26.9	26.6	26
28	26.1	25.9	25.4	25.1	25.0	24.7	24.3	23.8	23.5	28
30	23.4	23.2	22.7	22.4	22.3	22.0	21.6	21.2	20.8	30
32	21.1	21.0	20.4	20.2	20.0	19.8	19.3	19.0	18.6	32
34	19.1	19.0	18.4	18.2	18.0	17.8	17.3	17.0	16.6	34
36	17.3	17.2	16.7	16.5	16.3	16.1	15.6	15.3	14.8	36
38	15.8	15.7	15.1	15.0	14.7	14.6	14.0	13.8	13.3	38
40	14.4	14.3	13.6	13.5	13.3	13.2	12.7	12.5	11.9	40
42	13.0	13.0	12.2	12.1	12.1	12.0	11.4	11.3	10.5	42
44	11.7	11.7	11.0	10.9	11.0	10.9	10.1	10.0	9.3	44
46	44.2m x 11.5t	44.2m x 11.4t	44.2m x 10.7t	44.2m x 10.6t	44.2m x 10.7t	44.2m x 10.6t	44.2m x 9.9t	44.2m x 9.8t	44.2m x 9.0t	46
48										48

1. 上表に示す定格総荷重は、水平堅土上の定置荷役における値で、転倒荷重の78%以内、および移動式クレーン構造規格で定める前方安定度1.15以上です。
2. 実際につり上げられる荷重は、上表の定格総荷重から「主フック+補フック」などのつり具一切の質量を差し引いた値です。
3. 口太線の値は強度に基づいています。
4. 作業半径とは、荷をついた状態での旋回中心からつり荷の重心までの水平距離です。
5. カウンタウエイトは、標準仕様(105.2t)です。
6. 表中の〇〇m x 〇〇t は、作業半径 m x 定格総荷重 t を示します。
7. 巻上ロープ掛数と定格総荷重の最大値は下表のとおりです。

フック 容量	フック 質量(t)	定格総荷重の最大値(t)					
		6本掛	5本掛	4本掛	3本掛	2本掛	1本掛
80t	2.0	80	67.5	54	40.5	27	-
35t	1.07	-	-	-	35	27	-
13.5t	0.62	-	-	-	-	-	13.5

## ■クレーンジブ付き主ブーム(クレーン専用ブーム・タワー併用ブーム共通)



										(単位 t)
ブーム長さ(m)	52									ブーム長さ(m)
ジブ長さ(m)	13		19		25		31		37	ジブ長さ(m)
オフセット角度(°)	10	30	10	30	10	30	10	30	10	オフセット角度(°)
作業半径(m)										作業半径(m)
8	11.6m x	11.6m x	11.6m x	11.6m x	11.6m x	11.6m x	11.6m x	11.6m x	11.6m x	8
10	62.6t	62.5t	61.5t	61.4t	60.3t	60.2t	59.0t	58.9t	57.7t	10
12	62.1	62.0	61.0	60.9	59.8	59.7	58.5	58.4	57.2	12
14	59.1	59.0	58.1	58.0	56.9	56.8	55.7	55.6	54.5	14
16	56.4	56.1	55.8	55.1	54.3	54.2	53.1	53.0	51.9	16
18	48.3	47.9	47.6	46.9	47.2	46.5	46.5	45.5	45.7	18
20	41.9	41.5	41.1	40.6	40.8	40.2	40.1	39.2	39.3	20
22	36.7	36.4	36.0	35.5	35.6	35.1	34.9	34.2	34.1	22
24	32.4	32.1	31.7	31.3	31.4	30.9	30.7	30.0	29.9	24
26	28.9	28.6	28.2	27.8	27.8	27.4	27.1	26.6	26.4	26
28	25.8	25.6	25.1	24.8	24.7	24.4	24.0	23.5	23.3	28
30	23.1	22.9	22.4	22.1	22.1	21.7	21.3	20.9	20.6	30
32	20.8	20.6	20.1	19.9	19.7	19.5	19.0	18.7	18.3	32
34	18.8	18.6	18.1	17.9	17.7	17.5	17.1	16.7	16.3	34
36	17.0	16.9	16.4	16.2	16.0	15.8	15.3	15.0	14.6	36
38	15.5	15.4	14.7	14.5	14.4	14.3	13.8	13.5	13.0	38
40	14.0	13.9	13.2	13.0	13.1	12.9	12.4	12.2	11.5	40
42	12.6	12.5	11.8	11.7	11.8	11.7	11.0	10.8	10.1	42
44	11.3	11.2	10.5	10.4	10.6	10.5	9.8	9.6	8.9	44
46	10.2	10.1	9.4	9.3	9.4	9.3	8.6	8.5	7.8	46
48	46.8m x	46.8m x	46.8m x	46.8m x	46.8m x	46.8m x	46.8m x	46.8m x	46.8m x	48
50	9.7t	9.7t	9.0t	8.9t	9.0t	8.9t	8.2t	8.1t	7.3t	50

										(単位 t)
ブーム長さ(m)	55									ブーム長さ(m)
ジブ長さ(m)	13		19		25		31		37	ジブ長さ(m)
オフセット角度(°)	10	30	10	30	10	30	10	30	10	オフセット角度(°)
作業半径(m)										作業半径(m)
10	12.1m x	12.1m x	12.1m x	12.1m x	12.1m x	12.1m x	12.1m x	12.1m x	12.1m x	10
12	54.0t	54.0t	53.9t	53.9t	53.9t	53.9t	53.4t	53.3t	52.0t	12
14	54.0	54.0	53.9	53.8	52.6	52.5	51.4	51.3	50.1	14
16	52.6	52.5	51.7	51.6	50.5	50.4	49.3	49.2	48.0	16
18	48.1	47.7	47.4	46.8	47.1	46.4	46.3	45.4	45.6	18
20	41.7	41.3	41.0	40.4	40.7	40.0	40.0	39.1	39.2	20
22	36.5	36.2	35.8	35.4	35.5	35.0	34.8	34.1	34.1	22
24	32.3	32.0	31.6	31.2	31.3	30.8	30.6	29.9	29.8	24
26	28.8	28.5	28.1	27.7	27.8	27.3	27.1	26.5	26.3	26
28	25.8	25.5	25.1	24.7	24.8	24.4	24.0	23.5	23.3	28
30	23.1	22.9	22.4	22.1	22.1	21.7	21.4	20.9	20.6	30
32	20.8	20.6	20.1	19.8	19.7	19.4	19.1	18.7	18.3	32
34	18.7	18.6	18.1	17.8	17.7	17.5	17.1	16.7	16.3	34
36	17.0	16.8	16.2	16.0	16.0	15.7	15.3	15.0	14.6	36
38	15.4	15.2	14.5	14.3	14.4	14.2	13.7	13.5	13.0	38
40	13.8	13.7	13.0	12.8	13.0	12.8	12.3	12.0	11.4	40
42	12.4	12.3	11.6	11.5	11.7	11.6	10.9	10.7	10.1	42
44	11.2	11.1	10.4	10.3	10.5	10.3	9.7	9.5	8.8	44
46	10.0	10.0	9.3	9.2	9.3	9.2	8.5	8.4	7.7	46
48	9.0	8.9	8.2	8.2	8.3	8.2	7.5	7.4	6.7	48
50	49.4m x	49.4m x	49.4m x	49.4m x	49.4m x	49.4m x	49.4m x	49.4m x	49.4m x	50
52	8.2t	8.1t	7.4t	7.4t	7.4t	7.4t	6.7t	6.6t	5.8t	52

・注記は、29 ページに記載されています。

■クレーンジブ付き主ブーム(クレーン専用ブーム・タワー併用ブーム共通)



										(単位 t)
ブーム長さ(m)	58									ブーム長さ(m)
ジブ長さ(m)	13		19		25		31		37	ジブ長さ(m)
オフセット角度(°)	10	30	10	30	10	30	10	30	10	オフセット角度(°)
作業半径(m)										作業半径(m)
10	12.7m x	12.7m x	12.7m x	12.7m x	12.7m x	12.7m x	12.7m x	12.7m x	12.7m x	10
12	51.9t	51.8t	50.9t	50.8t	49.6t	49.5t	48.3t	48.2t	47.0t	12
14	50.6	50.5	49.5	49.4	48.3	48.2	47.0	46.9	45.7	14
16	48.4	48.3	47.5	47.4	46.3	46.2	45.2	45.1	43.9	16
18	46.2	46.1	45.3	45.2	44.2	44.1	43.2	43.1	42.0	18
20	41.4	41.0	40.7	40.1	40.4	39.7	39.7	38.8	38.9	20
22	36.2	35.9	35.5	35.1	35.2	34.7	34.6	33.8	33.8	22
24	32.0	31.7	31.3	30.9	31.0	30.5	30.4	29.7	29.6	24
26	28.5	28.2	27.8	27.4	27.5	27.1	26.8	26.3	26.1	26
28	25.5	25.3	24.8	24.5	24.5	24.1	23.9	23.4	23.2	28
30	22.9	22.7	22.2	21.9	21.9	21.5	21.2	20.7	20.5	30
32	20.6	20.4	19.9	19.6	19.6	19.3	18.9	18.5	18.2	32
34	18.6	18.4	17.8	17.5	17.6	17.3	16.9	16.5	16.2	34
36	16.8	16.6	15.9	15.7	15.8	15.6	15.1	14.8	14.4	36
38	15.1	14.9	14.2	14.0	14.2	14.0	13.6	13.2	12.7	38
40	13.5	13.4	12.7	12.5	12.9	12.6	12.1	11.7	11.2	40
42	12.1	12.0	11.4	11.2	11.5	11.3	10.7	10.4	9.8	42
44	10.9	10.8	10.1	10.0	10.2	10.1	9.4	9.2	8.6	44
46	9.8	9.7	9.0	8.9	9.1	8.9	8.3	8.1	7.5	46
48	8.7	8.6	8.0	7.9	8.1	7.9	7.3	7.1	6.4	48
50	7.8	7.7	7.0	6.9	7.1	7.0	6.3	6.2	5.5	50
52	6.9	6.8	6.1	6.1	6.2	6.1	5.4	5.4	4.6	52

										(単位 t)
ブーム長さ(m)	61									ブーム長さ(m)
ジブ長さ(m)	13		19		25		31		37	ジブ長さ(m)
オフセット角度(°)	10	30	10	30	10	30	10	30	10	オフセット角度(°)
作業半径(m)										作業半径(m)
10	13.2m x	13.2m x	13.2m x	13.2m x	13.2m x	13.2m x	13.2m x	13.2m x	13.2m x	10
12	46.1t	46.0t	45.1t	45.0t	43.8t	43.7t	42.6t	42.5t	41.4t	12
14	45.2	45.1	44.2	44.1	43.0	42.9	41.8	41.7	40.6	14
16	43.3	43.2	42.3	42.2	41.1	41.0	40.0	39.9	38.8	16
18	41.4	41.3	40.5	40.4	39.3	39.2	38.2	38.1	37.1	18
20	39.6	39.5	38.7	38.6	37.6	37.5	36.6	36.5	35.4	20
22	35.8	35.5	35.1	34.6	34.8	34.3	34.2	33.4	33.4	22
24	31.6	31.3	30.9	30.5	30.6	30.1	30.0	29.3	29.3	24
26	28.1	27.8	27.4	27.0	27.1	26.7	26.5	25.9	25.8	26
28	25.1	24.9	24.5	24.1	24.2	23.8	23.5	23.0	22.8	28
30	22.6	22.3	21.9	21.5	21.6	21.2	20.9	20.4	20.2	30
32	20.2	20.0	19.5	19.1	19.3	18.9	18.6	18.2	17.9	32
34	18.1	17.9	17.3	17.0	17.2	16.9	16.6	16.2	15.8	34
36	16.2	16.0	15.4	15.1	15.5	15.2	14.8	14.3	13.9	36
38	14.5	14.3	13.7	13.5	13.9	13.6	13.1	12.7	12.2	38
40	13.0	12.8	12.2	12.0	12.4	12.1	11.6	11.2	10.7	40
42	11.6	11.5	10.8	10.7	11.0	10.8	10.2	9.9	9.4	42
44	10.4	10.3	9.6	9.4	9.7	9.6	9.0	8.7	8.1	44
46	9.3	9.2	8.5	8.3	8.6	8.4	7.8	7.6	7.0	46
48	8.2	8.1	7.5	7.3	7.6	7.4	6.8	6.6	6.0	48
50	7.3	7.2	6.5	6.4	6.6	6.5	5.9	5.7	5.1	50
52	6.4	6.3	5.7	5.6	5.8	5.7	5.0	4.9	4.2	52
54	5.6	5.5	4.9	4.8	4.9	4.9	4.2	4.1	3.4	54
56	54.6m x	54.6m x	54.6m x	54.6m x	54.6m x	54.6m x	54.6m x	54.6m x	54.6m x	56
58	5.4t	5.3t	4.6t	4.6t	4.7t	4.6t	4.0t	3.9t	3.2t	58

・注記は、29 ページに記載されています。

■クレーンジブ付き主ブーム(クレーン専用ブーム・タワー併用ブーム共通)



										(単位 t)
ブーム長さ(m)	64								ブーム長さ(m)	
ジブ長さ(m)	13		19		25		31		37	ジブ長さ(m)
オフセット角度(°)	10	30	10	30	10	30	10	30	10	オフセット角度(°)
作業半径(m)										作業半径(m)
10	13.8m x	13.8m x	13.8m x	13.8m x	13.8m x	13.8m x	13.8m x	13.8m x	13.8m x	10
12	40.5t	40.5t	40.5t	40.5t	39.7t	39.6t	38.5t	38.4t	37.2t	12
14	40.5	40.5	40.5	40.5	39.6	39.5	38.4	38.3	37.2	14
16	40.0	39.9	39.1	39.0	38.0	37.9	36.9	36.8	35.7	16
18	38.4	38.3	37.3	37.2	36.2	36.1	35.2	35.1	34.1	18
20	36.5	36.4	35.6	35.5	34.6	34.5	33.6	33.5	32.5	20
22	34.7	34.6	33.9	33.8	32.9	32.8	32.0	31.9	31.0	22
24	31.5	31.2	30.8	30.4	30.6	30.1	29.6	29.2	29.2	24
26	28.0	27.7	27.4	27.0	27.1	26.6	26.4	25.8	25.7	26
28	25.0	24.8	24.4	24.0	24.1	23.7	23.5	22.9	22.8	28
30	22.5	22.3	21.8	21.4	21.6	21.2	20.9	20.4	20.2	30
32	20.2	19.9	19.3	19.0	19.3	18.9	18.6	18.2	17.8	32
34	18.0	17.8	17.2	16.9	17.2	16.9	16.6	16.1	15.7	34
36	16.1	15.9	15.3	15.0	15.5	15.1	14.7	14.2	13.8	36
38	14.4	14.2	13.6	13.3	13.8	13.5	13.0	12.6	12.1	38
40	12.9	12.7	12.1	11.8	12.3	12.0	11.5	11.1	10.6	40
42	11.5	11.3	10.7	10.5	10.9	10.6	10.1	9.8	9.3	42
44	10.2	10.1	9.5	9.3	9.6	9.4	8.9	8.6	8.0	44
46	9.1	9.0	8.4	8.2	8.5	8.3	7.7	7.5	6.9	46
48	8.1	8.0	7.3	7.2	7.5	7.3	6.7	6.5	5.9	48
50	7.1	7.0	6.4	6.3	6.5	6.4	5.8	5.6	5.0	50
52	6.3	6.2	5.5	5.4	5.6	5.5	4.9	4.7	4.1	52
54	5.4	5.4	4.7	4.6	4.8	4.7	4.1	4.0	3.3	54
56	4.7	4.6	4.0	3.9	4.1	4.0	3.3	3.2	54.2m x	56
58	57.2m x	57.2m x	57.2m x	57.2m x	57.2m x	57.2m x	56.2m x		3.2t	58
60	4.1t	4.1t	3.4t	3.4t	3.5t	3.4t	3.2t			60

										(単位 t)
ブーム長さ(m)	67								ブーム長さ(m)	
ジブ長さ(m)	13		19		25		31		37	ジブ長さ(m)
オフセット角度(°)	10	30	10	30	10	30	10	30	10	オフセット角度(°)
作業半径(m)										作業半径(m)
12	14.3m x	14.3m x	14.3m x	14.3m x	14.3m x	14.3m x	14.3m x	14.3m x	14.3m x	12
14	38.0t	37.9t	37.0t	36.9t	35.8t	35.7t	34.7t	34.6t	33.4t	14
16	36.7	36.6	35.8	35.7	34.7	34.6	33.5	33.4	32.4	16
18	35.1	35.0	34.2	34.1	33.1	33.0	32.0	31.9	30.9	18
20	33.4	33.3	32.6	32.5	31.5	31.4	30.5	30.4	29.5	20
22	31.8	31.7	31.0	30.9	30.0	29.9	29.1	29.0	28.0	22
24	30.1	30.0	29.3	29.2	28.3	28.2	27.4	27.3	26.5	24
26	27.8	27.5	27.1	26.7	26.9	26.4	25.6	25.5	24.7	26
28	24.8	24.6	24.2	23.8	23.9	23.5	23.3	22.7	22.6	28
30	22.3	22.0	21.5	21.1	21.4	21.0	20.7	20.2	20.0	30
32	19.8	19.6	19.0	18.7	19.1	18.8	18.5	17.9	17.6	32
34	17.7	17.5	16.9	16.5	17.1	16.7	16.3	15.8	15.5	34
36	15.8	15.6	15.0	14.7	15.2	14.9	14.4	14.0	13.6	36
38	14.1	13.9	13.3	13.0	13.5	13.2	12.7	12.3	11.9	38
40	12.6	12.4	11.8	11.5	12.0	11.7	11.2	10.8	10.4	40
42	11.2	11.1	10.4	10.2	10.6	10.4	9.9	9.5	9.0	42
44	10.0	9.8	9.2	9.0	9.4	9.2	8.6	8.3	7.8	44
46	8.8	8.7	8.1	7.9	8.3	8.1	7.5	7.2	6.7	46
48	7.8	7.7	7.1	6.9	7.2	7.0	6.5	6.2	5.7	48
50	6.9	6.8	6.1	6.0	6.3	6.1	5.5	5.3	4.7	50
52	6.0	5.9	5.3	5.2	5.4	5.3	4.7	4.5	3.9	52
54	5.2	5.1	4.5	4.4	4.6	4.5	3.9	3.7	53.7m x	54
56	4.4	4.4	3.7	3.7	3.9	3.8	55.7m x	55.4m x	3.2t	56
58	3.8	3.7	57.4m x	57.4m x	3.2	57.7m x	3.2t	3.2t		58
60	59.6m x	59.3m x	3.2t	3.2t		3.2t				60
62	3.2t	3.2t								62

・注記は、29 ページに記載されています。



■クレーンジブ付き主ブーム(クレーン専用ブーム・タワー併用ブーム共通)



										(単位 t)
ブーム長さ(m)	70									ブーム長さ(m)
ジブ長さ(m)	13		19		25		31		37	ジブ長さ(m)
オフセット角度(°)	10	30	10	30	10	30	10	30	10	オフセット角度(°)
作業半径(m)										作業半径(m)
12	14.8m x	14.8m x	14.8m x	14.8m x	14.8m x	14.8m x	14.8m x	14.8m x	14.8m x	12
14	33.4t	33.3t	32.4t	32.3t	31.2t	31.1t	30.1t	30.0t	28.9t	14
16	32.6	32.5	31.6	31.5	30.5	30.4	29.4	29.3	28.2	16
18	31.2	31.1	30.3	30.2	29.1	29.0	28.1	28.0	26.9	18
20	29.9	29.8	29.0	28.9	27.9	27.8	26.8	26.7	25.7	20
22	28.6	28.5	27.7	27.6	26.6	26.5	25.6	25.5	24.5	22
24	27.4	27.3	26.5	26.4	25.5	25.4	24.5	24.4	23.4	24
26	25.6	25.5	24.8	24.7	23.9	23.8	22.9	22.8	21.9	26
28	23.8	23.7	23.1	23.0	22.2	22.1	21.4	21.3	20.5	28
30	21.4	21.2	21.0	20.5	20.6	20.5	19.8	19.7	19.0	30
32	19.3	19.1	18.5	18.1	18.8	18.3	18.0	17.4	17.1	32
34	17.2	17.0	16.4	16.0	16.6	16.2	15.9	15.3	15.0	34
36	15.3	15.1	14.5	14.2	14.7	14.4	14.0	13.5	13.1	36
38	13.6	13.4	12.8	12.5	13.1	12.7	12.3	11.8	11.5	38
40	12.1	11.9	11.3	11.1	11.5	11.2	10.8	10.4	10.0	40
42	10.7	10.6	10.0	9.7	10.2	9.9	9.4	9.1	8.6	42
44	9.5	9.3	8.7	8.5	8.9	8.7	8.2	7.9	7.4	44
46	8.4	8.2	7.6	7.4	7.8	7.6	7.1	6.8	6.3	46
48	7.3	7.2	6.6	6.4	6.8	6.6	6.0	5.8	5.2	48
50	6.4	6.3	5.7	5.5	5.8	5.7	5.1	4.9	4.3	50
52	5.5	5.4	4.8	4.7	5.0	4.8	4.2	4.0	3.5	52
54	4.7	4.7	4.0	3.9	4.2	4.0	3.4	3.3	52.7m x	54
56	4.0	3.9	3.3	3.2	3.4	3.3	54.5m x	54.2m x	3.2t	56
58	3.3	3.2	56.2m x		56.5m x	56.2m x	3.2t	3.2t		58
60	58.2m x		3.2t		3.2t	3.2t				60
62	3.2t									62

										(単位 t)
ブーム長さ(m)	73									ブーム長さ(m)
ジブ長さ(m)	13		19		25		31		37	ジブ長さ(m)
オフセット角度(°)	10	30	10	30	10	30	10	30	10	オフセット角度(°)
作業半径(m)										作業半径(m)
12	15.4m x	15.4m x	15.4m x	15.4m x	15.4m x	15.4m x	15.4m x	15.4m x	15.4m x	12
14	30.9t	30.8t	29.9t	29.8t	28.8t	28.7t	27.7t	27.5t	26.5t	14
16	30.5	30.4	29.5	29.4	28.4	28.3	27.3	27.2	26.1	16
18	29.1	29.0	28.2	28.1	27.1	27.0	26.0	25.9	24.9	18
20	27.6	27.5	26.8	26.7	25.7	25.6	24.7	24.6	23.7	20
22	26.2	26.1	25.4	25.3	24.4	24.3	23.4	23.3	22.4	22
24	24.8	24.7	24.0	23.9	23.1	23.0	22.2	22.1	21.2	24
26	23.3	23.2	22.6	22.5	21.7	21.6	20.8	20.7	19.9	26
28	21.6	21.5	20.9	20.8	20.1	20.0	19.2	19.1	18.4	28
30	20.1	20.0	19.4	19.3	18.5	18.4	17.8	17.7	16.9	30
32	18.6	18.5	17.9	17.8	17.1	17.0	16.3	16.2	15.6	32
34	16.9	16.6	16.1	15.7	15.7	15.6	15.0	15.0	14.2	34
36	15.0	14.7	14.2	13.8	14.4	14.1	13.7	13.2	12.3	36
38	13.3	13.1	12.5	12.2	12.7	12.4	12.0	11.5	11.2	38
40	11.8	11.6	11.0	10.7	11.2	10.9	10.5	10.1	9.7	40
42	10.4	10.2	9.6	9.4	9.9	9.6	9.1	8.7	8.3	42
44	9.2	9.0	8.4	8.2	8.6	8.4	7.9	7.5	7.1	44
46	8.0	7.9	7.3	7.1	7.5	7.3	6.8	6.5	6.0	46
48	7.0	6.9	6.3	6.1	6.5	6.3	5.7	5.5	5.0	48
50	6.1	6.0	5.3	5.2	5.5	5.4	4.8	4.6	4.0	50
52	5.2	5.1	4.5	4.3	4.7	4.5	4.0	3.7	3.2	52
54	4.4	4.3	3.7	3.6	3.9	3.7	3.2	53.4m x		54
56	3.7	3.6	55.4m x	55.1m x	55.7m x	55.4m x		3.2t		56
58	57.4m x	57.1m x	3.2t	3.2t	3.2t	3.2t				58
60	3.2t	3.2t								60

・注記は、29 ページに記載されています。

作業範囲図

■主ブーム (タワー併用ブーム)

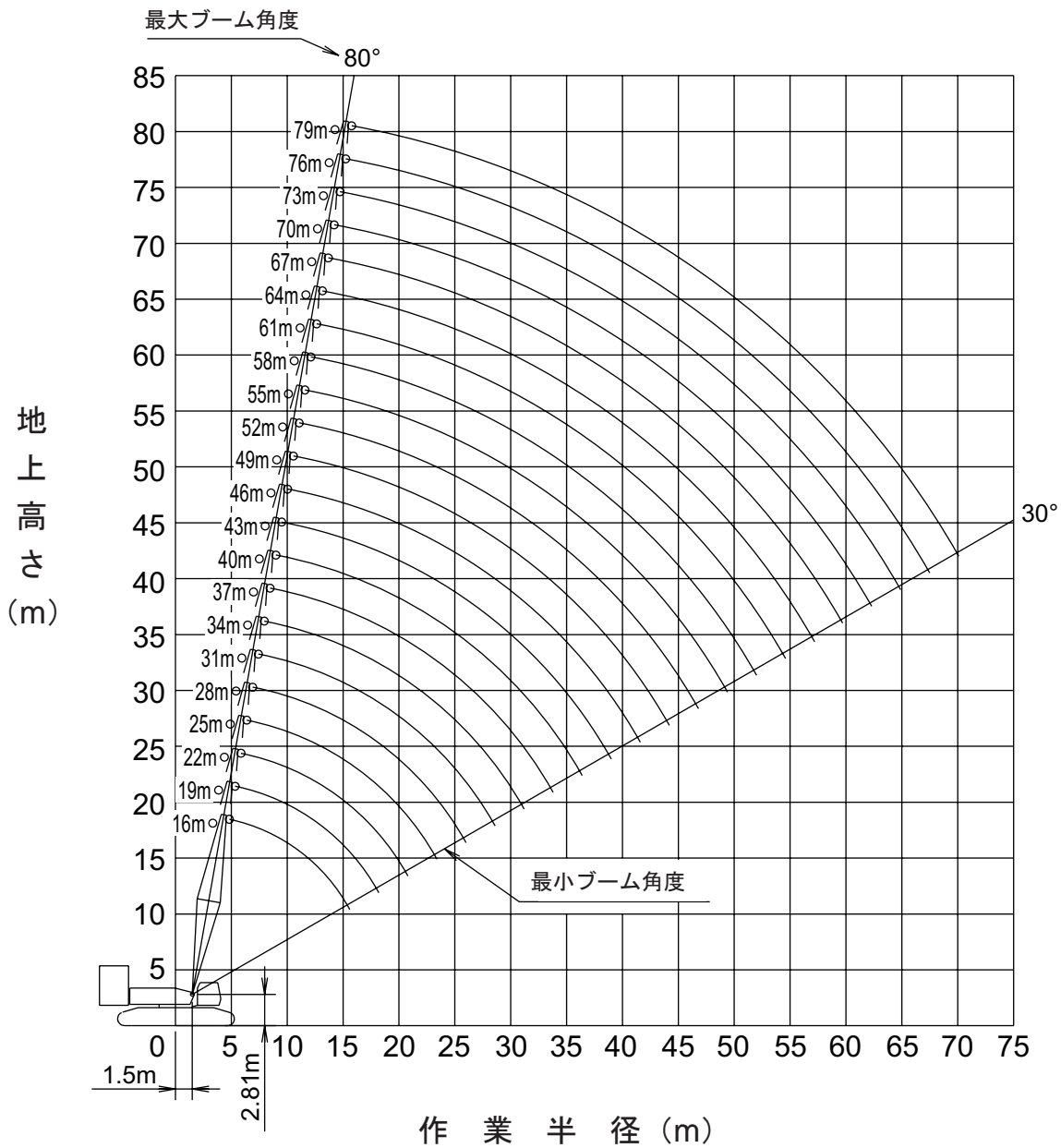
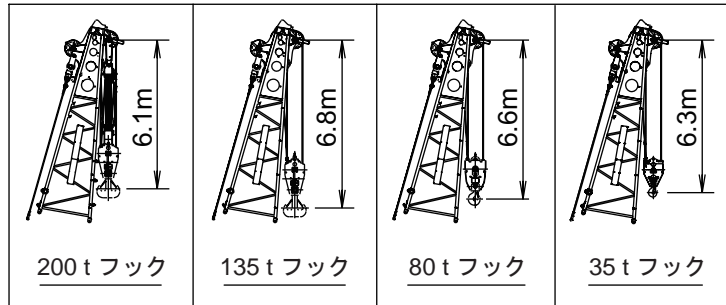

■補助シーブ (タワー併用ブーム)

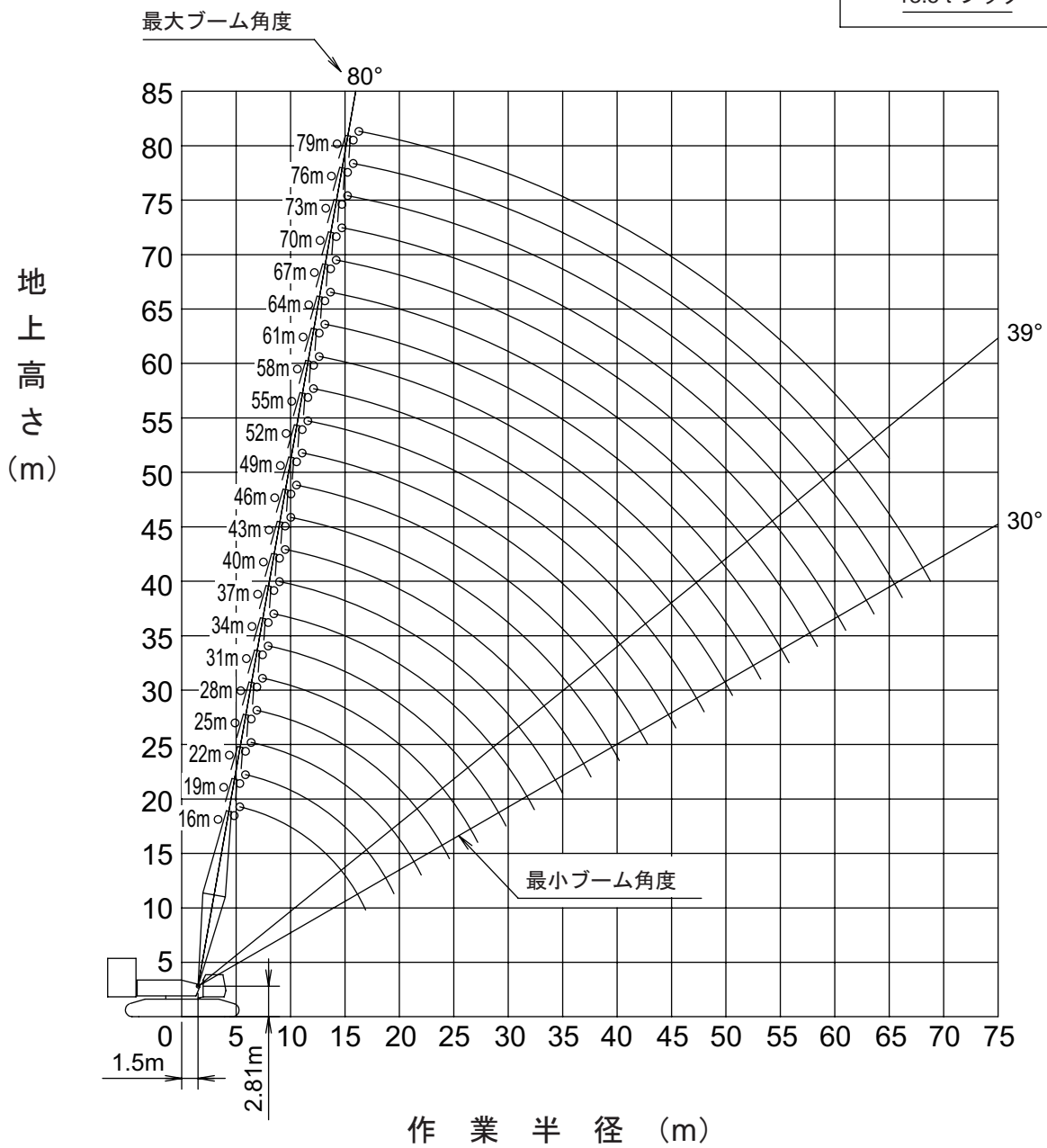
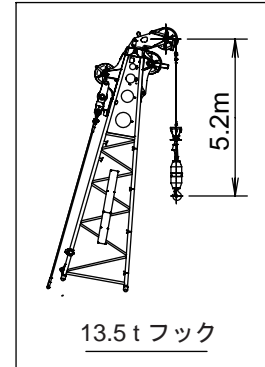

## 定格総荷重表

### ■主ブーム(タワー併用ブーム)



作業半径 (m)	主ブーム長さ(m)										作業半径 (m)	
	16	19	22	25	28	31	34	37	40	43		46
		5.6m x										
5	200.0	193.7t										5
6	189.8	189.6	6.1m x	6.6m x								6
7	164.1	163.9	181.1t	162.0t	7.2m x	7.7m x						7
8	144.5	144.3	163.5	162.0	150.8t	132.4t	8.3m x	8.8m x				8
9	129.0	128.8	143.9	143.4	143.1	132.0	128.2t	107.3t	9.4m x	9.9m x		9
10	116.5	116.3	128.4	127.9	127.6	124.9	124.8	106.6	103.0t	97.4t	10.5m x	10
12	90.7	90.6	115.8	115.4	115.1	114.7	114.4	103.5	99.8	97.0	88.5t	12
14	72.1	73.0	90.4	90.2	89.9	89.7	89.5	89.3	89.2	89.0	85.8	14
16	15.6m x	72.1	72.7	72.4	72.2	72.0	71.7	71.6	71.4	71.1	71.1	16
18	58.0t	61.0	60.7	60.4	60.1	60.0	59.8	59.8	59.7	59.7	59.3	18
20		52.4	52.4	52.0	51.7	51.3	51.1	51.2	51.2	51.2	51.0	20
22		18.2m x	45.7	45.2	45.5	44.6	44.6	44.5	44.6	44.6	44.4	22
24		51.6t	20.8m x	40.0	39.9	39.7	39.3	39.3	39.4	39.4	39.2	24
26			43.1t	23.4m x	35.3	35.4	35.5	35.1	35.2	35.1	34.9	26
28				36.7t	31.6	31.8	31.7	31.9	31.5	31.4	31.3	28
30						28.9	28.7	28.9	28.8	28.3	28.2	30
32						28.6m x	26.0	25.8	25.8	25.6	25.5	32
34						27.9t	31.2m x	23.5	23.5	23.3	23.2	34
36							24.5t	33.8m x	21.5	21.3	21.2	36
38								21.7t	19.7	19.5	19.4	38
40									36.4m x	18.0	17.9	40
42									19.4t	39.0m x	16.5	42
44										17.3t	41.6m x	44
											15.5t	

1. 上表に示す定格総荷重は、水平堅土上の定置荷役における値で、転倒荷重の78%以内、および移動式クレーン構造規格で定める前方安定度1.15以上です。
2. 実際につり上げられる荷重は、上表の定格総荷重からフックなどのつり具一切の質量を差し引いた値です。
3. 口太線内の値は強度に基づいています。
4. 作業半径とは、荷をついた状態での旋回中心からつり荷の重心までの水平距離です。
5. カウンタウエイトは、標準仕様(105.2t)です。
6. 表中の〇〇m x 〇〇t は、作業半径 m x 定格総荷重 t を示します。
7. 巻上ロープ掛数と定格総荷重の最大値は下表のとおりです。

フック 容量	フック 質量 (t)	定格総荷重の最大値(t)											
		16本掛	14本掛	12本掛	10本掛	8本掛	7本掛	6本掛	5本掛	4本掛	3本掛	2本掛	1本掛
200t	3.0	200	185	162	-	-	-	-	-	-	-	-	-
135t	2.6	-	-	-	135	108	94.5	81	67.5	54	40.5	27	-
80t	2.0	-	-	-	-	-	-	80	67.5	54	40.5	27	-
35t	1.07	-	-	-	-	-	-	-	-	-	35	27	-
13.5t	0.62	-	-	-	-	-	-	-	-	-	-	-	13.5

8. 16mブームは200tフックのみ、19mブームは80tフック以上の使用となります。

■主ブーム(タワー併用ブーム)



作業半径 (m)	主ブーム長さ(m)										作業半径 (m)		
	49	52	55	58	61	64	67	70	73	76		79	
9	11.0m x 81.0t	11.6m x 75.3t											9
10			12.1m x 73.5t	12.7m x 65.8t	13.2m x 59.5t	13.8m x 52.7t							10
12							14.3m x 49.6t	14.8m x 43.6t	15.4m x 38.2t	15.9m x 33.6t			12
14											16.5m x 29.3t		14
16													16
18													18
20													20
22													22
24													24
26													26
28													28
30													30
32													32
34													34
36													36
38													38
40													40
42													42
44													44
46	44.2m x 13.9t	12.9	12.6	12.6	12.1	12.0	11.9	11.6	11.6	11.6	11.3	11.0	46
48		46.8m x 12.4t	11.9	11.7	11.2	11.1	11.0	10.6	10.6	10.4	10.4	10.0	48
50			49.4m x 11.3t	10.9	10.4	10.3	10.2	9.8	9.7	9.5	9.5	9.2	50
52				10.1	9.6	9.6	9.5	9.0	9.0	8.7	8.7	8.4	52
54					8.9	8.9	8.7	8.3	8.2	8.0	8.0	7.7	54
56					54.6m x 8.9t	8.2	8.0	7.6	7.6	7.3	7.3	7.0	56
58						57.2m x 7.9t	7.4	7.0	6.9	6.7	6.7	6.4	58
60							59.7m x 7.0t	6.4	6.4	6.1	6.1	5.7	60
62								5.9	5.7	5.5	5.5	5.0	62
64								62.3m x 5.8t	5.2	4.9	4.9	4.5	64
66									64.9m x 5.0t	4.3	4.3	4.0	66
68										67.5m x 4.0t	4.0t	3.5	68
70												3.0	70
72												70.1m x 3.0t	72

・注記は、36 ページに記載されています。

## ■補助シーブ(タワー併用ブーム)



作業半径 (m)	主ブーム長さ(m)											作業半径 (m)
	16	19	22	25	28	31	34	37	40	43	46	
5.9	13.5	6.4m x	6.9m x									5.9
6	13.5	13.5t	13.5t	7.5m x								6
7	13.5	13.5	13.5	13.5t		8.6m x						7
8	13.5	13.5	13.5	13.5	13.5	13.5t						8
9	13.5	13.5	13.5	13.5	13.5	13.5	9.1m x	9.7m x				9
10	13.5	13.5	13.5	13.5	13.5	13.5	13.5t	13.5t	10.2m x	10.8m x	11.3m x	10
12	13.5	13.5	13.5	13.5	13.5	13.5	13.5	13.5	13.5	13.5	13.5	12
14	13.5	13.5	13.5	13.5	13.5	13.5	13.5	13.5	13.5	13.5	13.5	14
16	13.5	13.5	13.5	13.5	13.5	13.5	13.5	13.5	13.5	13.5	13.5	16
18	16.9m x	13.5	13.5	13.5	13.5	13.5	13.5	13.5	13.5	13.5	13.5	18
20	13.5t	19.5m x	13.5	13.5	13.5	13.5	13.5	13.5	13.5	13.5	13.5	20
22		13.5t	13.5	13.5	13.5	13.5	13.5	13.5	13.5	13.5	13.5	22
24				13.5	13.5	13.5	13.5	13.5	13.5	13.5	13.5	24
26				24.6m x	13.5	13.5	13.5	13.5	13.5	13.5	13.5	26
28				13.5t	27.2m x	13.5	13.5	13.5	13.5	13.5	13.5	28
30					13.5t	29.8m x	13.5	13.5	13.5	13.5	13.5	30
32						13.5t	13.5	13.5	13.5	13.5	13.5	32
34							32.4m x	13.5	13.5	13.5	13.5	34
36							13.5t	35.0m x	13.5	13.5	13.5	36
38								13.5t	37.6m x	13.5	13.5	38
40									13.5t	13.5	13.5	40
42										40.2m x	13.5	42
44										13.5t	42.8m x	44
46											13.5t	46

作業半径 (m)	主ブーム長さ(m)											作業半径 (m)
	49	52	55	58	61	64	67	70	73	76	79	
9	11.9m x											9
10	13.5t	12.4m x	13.0m x	13.5m x								10
12	13.5	13.5t	13.5t	13.5t	14.1m x	14.6m x	15.1m x	15.7m x				12
14	13.5	13.5	13.5	13.5	13.5t	13.5t	13.5t	13.5t	16.2m x	16.8m x	17.3m x	14
16	13.5	13.5	13.5	13.5	13.5	13.5	13.5	13.5	13.5t	13.5t	13.5t	16
18	13.5	13.5	13.5	13.5	13.5	13.5	13.5	13.5	13.5	13.5	13.5	18
20	13.5	13.5	13.5	13.5	13.5	13.5	13.5	13.5	13.5	13.5	13.5	20
22	13.5	13.5	13.5	13.5	13.5	13.5	13.5	13.5	13.5	13.5	13.5	22
24	13.5	13.5	13.5	13.5	13.5	13.5	13.5	13.5	13.5	13.5	13.5	24
26	13.5	13.5	13.5	13.5	13.5	13.5	13.5	13.5	13.5	13.5	13.5	26
28	13.5	13.5	13.5	13.5	13.5	13.5	13.5	13.5	13.5	13.5	13.5	28
30	13.5	13.5	13.5	13.5	13.5	13.5	13.5	13.5	13.5	13.5	13.5	30
32	13.5	13.5	13.5	13.5	13.5	13.5	13.5	13.5	13.5	13.5	13.5	32
34	13.5	13.5	13.5	13.5	13.5	13.5	13.5	13.5	13.5	13.5	13.5	34
36	13.5	13.5	13.5	13.5	13.5	13.5	13.5	13.5	13.5	13.5	13.1	36
38	13.5	13.5	13.5	13.5	13.5	13.5	13.5	13.5	13.5	13.5	12.1	38
40	13.5	13.5	13.5	13.5	13.5	13.5	13.5	13.5	13.5	12.6	11.2	40
42	13.5	13.5	13.5	13.5	13.5	13.5	13.5	13.4	13.0	11.7	10.3	42
44	13.5	13.5	13.3	13.2	12.9	12.8	12.6	12.3	12.1	10.8	9.4	44
46	45.4m x	12.5	12.3	12.2	11.9	11.8	11.6	11.3	11.2	10.0	8.6	46
48	13.1t	11.6	11.4	11.3	10.9	10.8	10.6	10.3	10.3	9.2	7.9	48
50			10.6	10.4	10.1	10.0	9.8	9.5	9.4	8.5	7.1	50
52			50.6m x	9.7	9.3	9.2	9.0	8.7	8.6	7.7	6.4	52
54			10.3t	53.2m x	8.6	8.5	8.3	8.0	7.9	7.1	5.8	54
56				9.2t	55.8m x	7.8	7.6	7.3	7.2	6.4	5.1	56
58					8.0t	7.2	7.0	6.7	6.6	5.8	4.5	58
60						58.4m x	6.4	6.1	6.0	5.1	3.9	60
62						7.1t	61.0m x	5.5	5.4	4.6	3.3	62
64							6.2t	63.6m x	4.8	3.9	2.8	64
66								5.0t	4.2	3.3	65.0m x	66
68									66.2m x	2.7	2.5t	68
70									4.1t	68.8m x		70
72										2.5t		72

1. 上表に示す定格総荷重は、水平堅土上の定置荷役における値で、転倒荷重の78%以内、および移動式クレーン構造規格で定める前方安定度1.15以上です。
2. 実際につり上げられる荷重は、上表の定格総荷重から「主フック+補フック」などのつり具一切の質量を差し引いた値です。
3. □太線の値は強度に基づいています。
4. 作業半径とは、荷をついた状態での旋回中心からつり荷の重心までの水平距離です。
5. カウンタウエイトは、標準仕様(105.2t)です。
6. 表中の○○m x ○○t は、作業半径 m x 定格総荷重 t を示します。
7. フック質量は下表のとおりです。

フック 容量	フック 質量 (t)
200t	3.0
135t	2.6
80t	2.0
35t	1.07
13.5t	0.62

■補助シーブ付き主ブーム(タワー併用ブーム)



作業半径 (m)	主ブーム長さ(m)											作業半径 (m)
	16	19	22	25	28	31	34	37	40	43	46	
		5.6m x 193.3t										
5	200.0		6.1m x 180.5t	6.6m x 162.0t								5
6	189.4	189.2			7.2m x 150.1t	7.7m x 131.8t						6
7	163.7	163.5					8.3m x 127.7t	8.8m x 106.8t				7
8	144.1	143.9	143.5	142.9	142.6	131.4			9.4m x 102.4t	9.9m x 96.8t		8
9	128.6	128.4	128.0	127.4	127.1	124.2	124.1	106.2			10.5m x 87.8t	9
10	116.1	115.9	115.4	114.9	114.6	114.2	113.9	103.1				10
12	90.3	90.2	89.9	89.7	89.4	89.2	89.0	88.8	88.7	88.2	85.0	12
14	71.7	72.5	72.2	71.9	71.7	71.5	71.2	71.1	70.9	70.6	70.5	14
16	15.6m x 57.6t	60.6	60.2	59.9	59.6	59.5	59.3	59.3	59.2	59.2	58.7	16
18		52.0	51.9	51.5	51.2	50.8	50.6	50.7	50.7	50.7	50.4	18
20		18.2m x 51.2t	45.3	44.7	45.0	44.1	44.1	44.0	44.1	44.1	43.8	20
22			20.8m x 42.7t	39.5	39.4	39.2	38.8	38.8	38.9	38.9	38.7	22
24				23.4m x 36.3t	34.8	34.9	35.0	34.6	34.7	34.6	34.4	24
26					31.1	31.3	31.2	31.4	31.0	30.9	30.8	26
28						28.4	28.2	28.4	28.3	27.8	27.6	28
30						28.6m x 27.4t	25.5	25.3	25.3	25.1	24.9	30
32							31.2m x 24.0t	23.0	23.0	22.8	22.7	32
34								33.8m x 21.2t	21.0	20.8	20.7	34
36									19.2	19.0	18.9	36
38									36.4m x 18.9t	17.5	17.4	38
40										39.0m x 16.8t	16.0	40
42											41.6m x 15.0t	42
44												44

作業半径 (m)	主ブーム長さ(m)											作業半径 (m)
	49	52	55	58	61	64	67	70	73	76	79	
9	11.0m x 80.2t	11.6m x 74.7t										9
10			12.1m x 72.8t	12.7m x 65.1t	13.2m x 58.7t	13.8m x 52.1t						10
12	77.2	74.2					14.3m x 48.8t	14.8m x 42.7t	15.4m x 37.3t	15.9m x 32.7t		12
14	70.2	69.7	68.1	63.1	57.4	51.9	46.8	41.8	36.9	32.7	16.5m x 28.4t	14
16	58.4	57.9	57.4	57.4	54.1	49.6	44.2	40.4	35.6	31.2	27.4	16
18	50.1	49.7	49.3	48.9	48.4	47.2	44.2	40.4	35.6	31.2	27.4	18
20	43.6	43.2	42.9	42.7	42.3	41.9	41.6	39.2	34.5	29.6	26.0	20
22	38.4	38.1	37.8	37.6	37.2	37.1	36.6	36.1	32.4	28.1	24.6	22
24	34.2	33.8	33.5	33.4	33.0	32.8	32.6	32.0	30.1	26.7	23.3	24
26	30.7	30.3	30.0	29.9	29.5	29.3	29.1	28.5	28.0	25.0	22.0	26
28	27.6	27.3	27.0	26.9	26.5	26.4	26.2	25.7	25.6	23.1	20.4	28
30	24.9	24.6	24.4	24.3	24.0	23.8	23.6	23.3	23.0	21.3	18.8	30
32	22.6	22.2	22.1	22.1	21.7	21.7	21.4	21.1	20.8	19.9	17.3	32
34	20.5	20.2	20.1	20.1	19.7	19.6	19.5	19.1	19.0	18.5	16.0	34
36	18.9	18.4	18.3	18.3	17.9	17.8	17.6	17.3	17.3	17.0	14.9	36
38	17.3	16.9	16.8	16.6	16.3	16.3	16.1	15.7	15.7	15.4	13.8	38
40	16.0	15.5	15.4	15.3	14.9	14.9	14.7	14.3	14.3	14.0	12.8	40
42	14.7	14.3	14.2	14.1	13.6	13.6	13.5	13.0	13.0	12.7	11.8	42
44	13.5	13.3	13.0	13.0	12.6	12.5	12.3	12.0	11.9	11.6	11.0	44
46	44.2m x 13.4t	12.4	12.1	12.0	11.5	11.4	11.3	11.0	10.9	10.6	10.2	46
48		46.8m x 11.9t	11.4	11.1	10.6	10.5	10.4	10.0	9.9	9.7	9.2	48
50			49.4m x 10.8t	10.4	9.8	9.7	9.6	9.2	9.1	8.8	8.4	50
52				9.6	9.0	9.0	8.9	8.4	8.4	7.9	7.6	52
54					8.4	8.3	8.1	7.7	7.6	7.2	6.9	54
56					54.6m x 8.4t	7.6	7.4	7.0	7.0	6.6	6.2	56
58						57.2m x 7.3t	6.8	6.4	6.3	6.0	5.6	58
60							59.7m x 6.4t	5.8	5.7	5.4	5.0	60
62								5.2	5.0	4.8	4.3	62
64								62.3m x 5.1t	4.5	4.2	3.8	64
66									64.9m x 4.3t	3.6	3.3	66
68										67.5m x 3.3t	2.8	68
70											69.2m x 2.5t	70
72												72

1. 上表に示す定格総荷重は、水平堅土上の定置荷役における値で、転倒荷重の78%以内、および移動式クレーン構造規格で定める前方安定度1.15以上です。
2. 実際につり上げられる荷重は、上表の定格総荷重から「主フック+補フック」などのつり具一切の質量を差し引いた値です。
3. □太線の値は強度に基づいています。
4. 作業半径とは、荷をついた状態での旋回中心からつり荷の重心までの水平距離です。
5. カウンタウエイトは、標準仕様(105.2t)です。
6. 表中の○○m x ○○t は、作業半径 m x 定格総荷重 t を示します。
7. 巻上ロープ掛数と定格総荷重の最大値は下表のとおりです。

フック 容量	フック 質量 (t)	定格総荷重の最大値(t)											
		16本掛	14本掛	12本掛	10本掛	8本掛	7本掛	6本掛	5本掛	4本掛	3本掛	2本掛	1本掛
200t	3.0	200	185	162	-	-	-	-	-	-	-	-	-
135t	2.6	-	-	-	135	108	94.5	81	67.5	54	40.5	27	-
80t	2.0	-	-	-	-	-	-	80	67.5	54	40.5	27	-
35t	1.07	-	-	-	-	-	-	-	-	-	35	27	-
13.5t	0.62	-	-	-	-	-	-	-	-	-	-	-	13.5

8. 16mブームは、200tフック、135tフックのみの使用となります。

## タワー仕様

## 寸法図／仕様

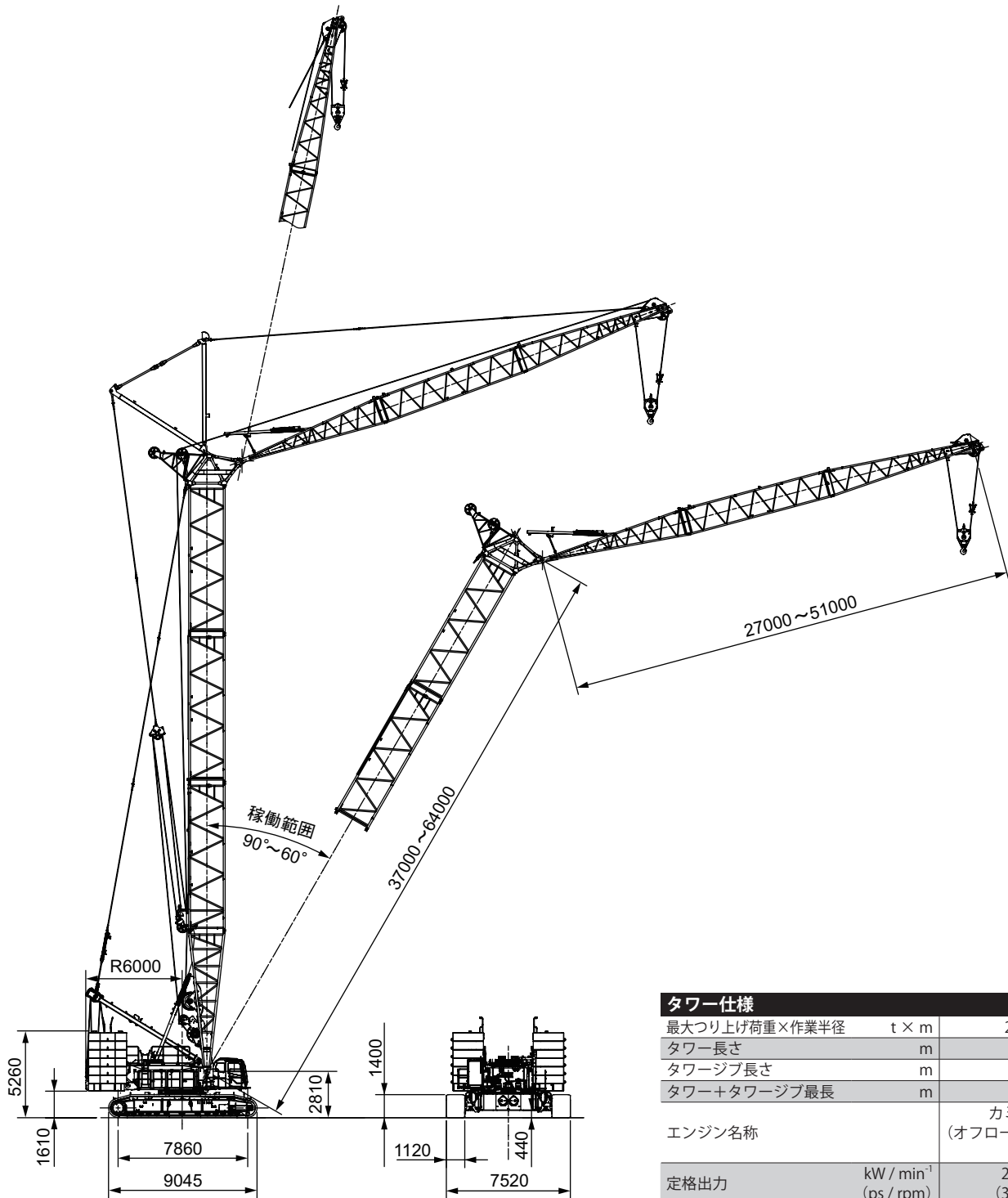

## タワー仕様

最大つり上げ荷重×作業半径	t × m	27 × 18.0
タワー長さ	m	37 ~ 64
タワージブ長さ	m	27 ~ 51
タワー+タワージブ最長	m	64 + 51
エンジン名称		カミンズ QSL9 (オフロード法 2014 年基準 適合)
定格出力	kW / min <sup>-1</sup> (ps / rpm)	272 / 2,000 (370 / 2,000)
接地圧	kPa (kgf / cm <sup>2</sup> )	130 (1.32) (タワー+タワージブ最長 35 t フック付)
全装備質量	t	233 (タワー+タワージブ最長 35 t フック付)

## 【注】

単位は、国際単位系 (SI) による表示です。( ) 内は、従来の単位表示を参考値として併記しました。



## タワーの標準構成表

タワー		タワー	
タワー長さ (m)	タワーブーム構成	タワー長さ (m)	タワーブーム構成
37		52	
40		55	
43		58	
46		61	
49		64	

図示省略寸法		
略記号	タワーブーム長さ (m)	備考
1.5	1.5	
3	3	
6	6	
8.5	8.5	
9	9	
9B	9	ジブ下部スプレッタ取付用
9C	9	レール付

ロープかきめ部の刻印により、ブームペンダントロープを判別してください。

ペンダントロープ			
略記号	長さ (m)	ロープ径 (mm)	刻印
3	3	35.5	35.5mm 3M
6	6	35.5	35.5mm 6M
9	9	35.5	35.5mm 9M
10.7	10.7 (両端メス金具)	35.5	35.5mm 10.7M

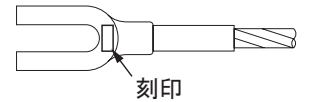



タワーブームとタワージブの組合せ										
ジブ長さ (m)		27	30	33	36	39	42	45	48	51
タワー長さ (m)	37	◎	◎	×	×	×	×	×	×	×
	40	◎	◎	◎	×	×	×	×	×	×
	43	◎	◎	◎	◎	×	×	×	×	×
	46	◎	◎	◎	◎	◎	×	×	×	×
	49	◎	◎	◎	◎	◎	◎	×	×	×
	52	◎	◎	◎	◎	◎	◎	◎	×	×
	55	◎	◎	◎	◎	◎	◎	◎	◎	×
	58	◎	◎	◎	◎	◎	◎	◎	◎	○
	61	◎	◎	◎	◎	◎	◎	◎	◎	○
	64	◎	◎	◎	◎	◎	◎	◎	○	○

表中の記号は下記のとおりです。

- ◎: 90°～60° 使用可能
- : 90°～70° 使用可能
- ×: 使用不可

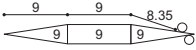
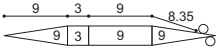
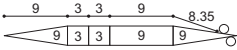
### タワージブ

タワージブ長さ (m)	タワージブ構成
27	
30	
33	
36	

### タワージブ

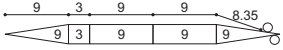
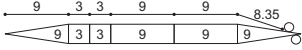
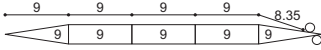
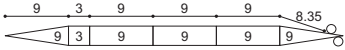
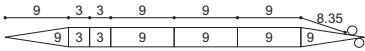
タワージブ長さ (m)	タワージブ構成
39	
42	
45	
48	
51	

### 図示省略寸法

略記号	タワージブ長さ (m)	備考
3	3	
9	9	

ロープかしめ部の刻印により、タワージブペンダントロープを判別してください。

### タワージブペンダントロープ

略記号	長さ (m)	ロープ径 (mm)	刻印
3	3	35.5	35.5mm 3M
9	9	35.5	35.5mm 9M
8.35	8.35 (両端メス金具)	35.5	35.5mm 8.35M



# 作業範囲図

## タワーブーム

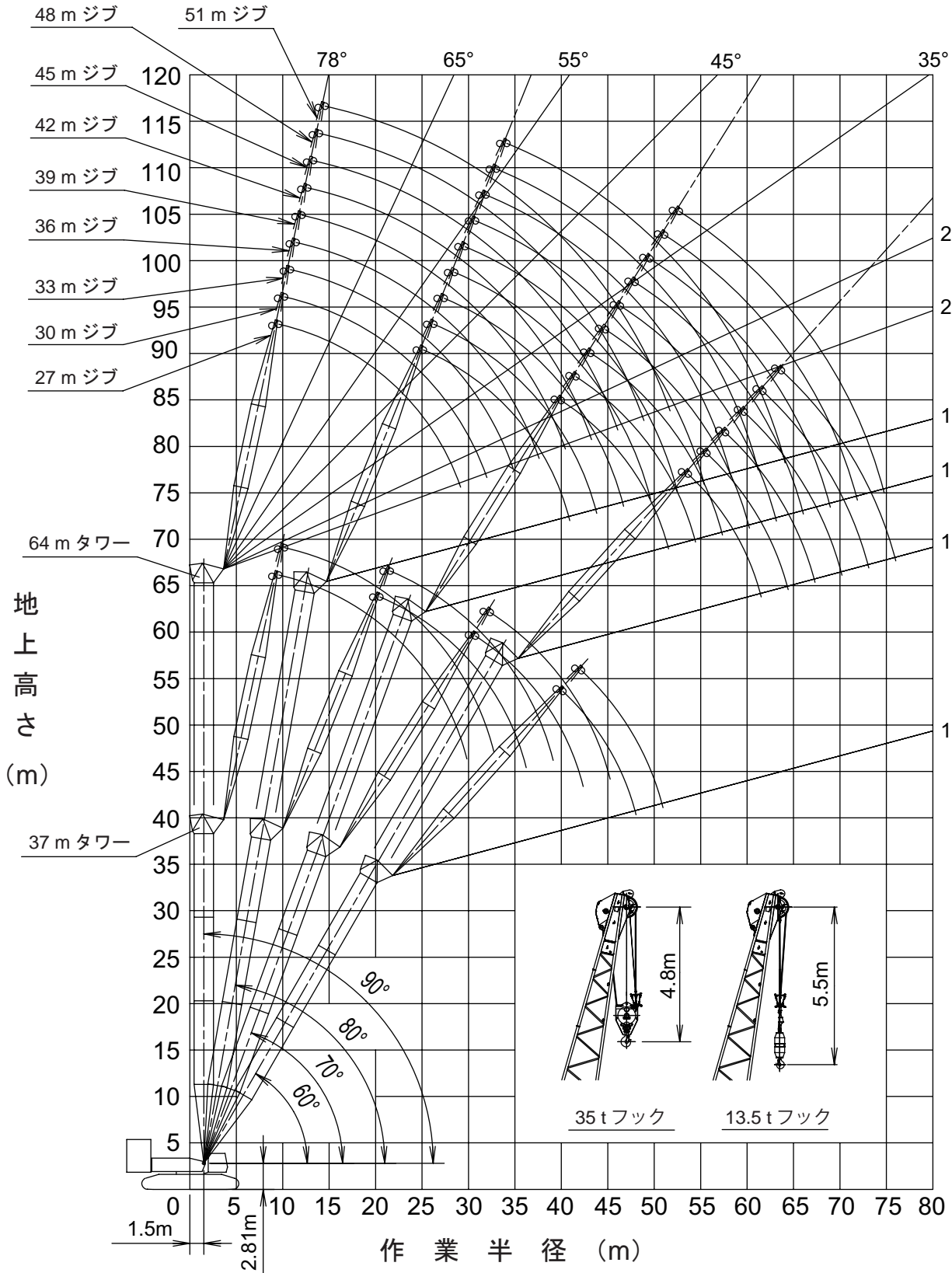

## 定格総荷重表

## ■ 37 m タワー



タワー長さ(m) タワージブ長さ(m) タワー角(°) 作業半径(m)	37								タワー長さ(m) タワージブ長さ(m) タワー角(°) 作業半径(m)
	27				30				
	90	80	70	60	90	80	70	60	
9.7	27.0				10.4m x 27.0t				9.7
10	27.0				27.0				10
12	27.0				27.0				12
14	27.0				27.0				14
16	27.0				27.0				16
18	27.0	20.2m x 25.4t			26.4	21.4m x 24.5t			18
20	25.3				24.6				20
22	23.3	24.3			22.9	24.2			22
24	21.3	23.2			21.3	23.1			24
26	19.1	21.1			19.6	21.0			26
28	15.1	19.3	30.4m x		17.8	19.2			28
30	28.4m x	17.7	17.2t		14.9	17.6			30
32	13.9t	16.4	16.2t		31.2m x 12.2t	16.3	16.1		32
34	*29.4m x	15.2	15.1		12.2t	15.2	14.9		34
36	10.9t	35.4m x 14.5t	14.1	39.7m x 12.0t	*32.2m x 9.9t	14.1	13.9		36
38			13.2	11.9		13.2	13.1	41.7m x 11.1t	38
40		*36.5m x 12.1t	12.4	11.2		38.3m x 13.1t	12.3	11.0	40
42			41.6m x 11.8t	10.5		*39.4m x 10.7t	11.6	10.4	42
44				10.0			10.9	10.4	44
46			*42.6m x 11.4t	9.4t			44.5m x 10.8t	9.9	46
48				47.3m x 9.6t			10.8t	9.4	48
50				*48.3m x 9.4t			*45.5m x 10.5t	8.9	50
52								50.2m x 8.8t	52
54								*51.2m x 8.6t	54

## ■ 40 m タワー



タワー長さ(m) タワージブ長さ(m) タワー角(°) 作業半径(m)	40								タワー長さ(m) タワージブ長さ(m) タワー角(°) 作業半径(m)
	27				30				
	90	80	70	60	90	80	70	60	
8	9.7m x				10.4m x				8
9	27.0t				27.0t				9
10	27.0				27.0				10
12	27.0				27.0				12
14	27.0				27.0				14
16	27.0				27.0				16
18	27.0	20.8m x 25.0t			26.4	21.9m x 24.2t			18
20	25.3				24.6				20
22	23.3	24.3			22.9	24.2			22
24	21.3	23.2			21.3	23.1			24
26	19.1	21.0			19.6	20.9			26
28	15.2	19.2	31.4m x		17.8	19.1			28
30	28.4m x	17.7	16.3t		15.1	17.6	33.0m x		30
32	14.0t	16.4	15.9		31.2m x 12.3t	16.3	15.2t		32
34	*29.4m x	15.2	14.8		12.3t	15.1	14.7		34
36	11.0t	14.2	13.8		*32.2m x 10.0t	14.1	13.7		36
38		*37.0m x 12.4t	12.9	41.2m x 11.3t		13.2	12.8		38
40			12.2	11.0		38.9m x 12.9t	12.0	43.2m x 10.5t	40
42			42.6m x 11.3t	10.4		*39.9m x 10.9t	11.3	10.3	42
44				9.9			10.7	10.3	44
46			*43.6m x 10.9t	9.4			45.5m x 10.3t	9.7	46
48				48.8m x 9.2t				9.2	48
50				*49.8m x 8.9t			*46.5m x 10.0t	8.8	50
52								51.7m x 8.4t	52
54								*52.7m x 8.2t	54
56									56

1. 上表に示す定格総荷重は、水平堅土上の定置荷役における値で、転倒荷重の78%以内、および移動式クレーン構造規格で定める前方安定度1.15以上です。
2. 実際につり上げられる荷重は、上表の定格総荷重からフックなどのつり具一切の質量を差し引いた値です。
3. 口太線の値は強度に基づいています。
4. 作業半径とは、荷をつった状態での旋回中心からつり荷の重心までの水平距離です。
5. カウンタウエイトは、標準仕様(105.2t)です。
6. 表中の○○m x ○○t は、作業半径 m x 定格総荷重 t を示します。
7. 本表は、2本掛の値を示します。ただし\*印の作業半径は、1本掛での最大作業半径を示します。
8. 使用するフックは、以下の通りです。  
2本掛・・・35t フック (フック質量 1.07t)  
1本掛・・・13.5t フック (フック質量 0.62t)

■ 40 m タワー



(単位 t)

タワー長さ(m)	40				タワー長さ(m)
タワージブ長さ(m)	33				タワージブ長さ(m)
タワー角(°)	90	80	70	60	タワー角(°)
作業半径(m)					作業半径(m)
9	11.0m x 27.0t				9
10	27.0				10
12	27.0				12
14	27.0				14
16	27.0				16
18	25.5				18
20	23.9	23.0m x 23.0t			20
22	22.5				22
24	21.1	22.5			24
26	19.5	20.4			26
28	17.8	18.6			28
30	16.2	17.1			30
32	14.5	15.8	34.6m x 14.0t		32
34	11.1	14.7			34
36	*35.0m x 8.9t	13.7	13.3		36
38		12.9	12.5		38
40		12.1	11.7		40
42		41.8m x 11.4t	11.0	45.2m x 9.8t	42
44		*42.8m x 10.0t	10.4	9.6	44
46			9.9	9.6	46
48			9.3	9.1	48
50			48.4m x 9.2t	8.6	50
52				8.2	52
54			*49.4m x 9.0t	7.8	54
56				54.6m x 7.7t	56
58				*55.6m x 7.5t	58

■ 43 m タワー



(単位 t)

タワー長さ(m)	43								タワー長さ(m)
タワージブ長さ(m)	27				30				タワージブ長さ(m)
タワー角(°)	90	80	70	60	90	80	70	60	タワー角(°)
作業半径(m)									作業半径(m)
8	9.7m x 27.0t								8
9	27.0				10.4m x 27.0t				9
10	27.0				27.0				10
12	27.0				27.0				12
14	27.0				27.0				14
16	27.0				27.0				16
18	27.0	21.3m x 24.5t			26.4				18
20	25.3	24.2			24.6	22.4m x 23.9t			20
22	23.3	23.1			22.9	23.1			22
24	21.3	21.0			21.3	23.1			24
26	19.1	19.2			19.6	20.9			26
28	15.3	17.7	32.5m x 15.5t		17.8	19.1			28
30	28.4m x 14.1t	17.7			15.2	17.6			30
32		16.3			31.2m x 12.4t	16.3	34.1m x 14.5t		32
34	*29.4m x 11.1t	15.2	14.7			15.1			34
36		14.2	13.7		*32.2m x 10.1t	14.1	13.6		36
38		36.5m x 13.9t	12.9			13.2	12.7		38
40			12.1	42.7m x 10.7t		39.4m x 12.6t	12.0		40
42		*37.5m x 12.2t	11.4				11.3	44.7m x 10.0t	42
44			43.6m x 10.9t	10.3		*40.4m x 11.2t	10.6		44
46			10.9t	9.8			10.1	9.6	46
48			*44.6m x 10.5t	9.3			46.5m x 9.9t	9.1	48
50				8.8				8.7	50
52				50.3m x 8.7t			*47.5m x 9.7t	8.3	52
54								53.2m x 8.0t	54
56				*51.3m x 8.5t					56
58								*54.2m x 7.8t	58

・注記は、44 ページに記載されています。

## ■ 43 m タワー



タワー長さ(m) タワージブ長さ(m) タワー角(°) 作業半径(m)	43								タワー長さ(m) タワージブ長さ(m) タワー角(°) 作業半径(m)
	33				36				
	90	80	70	60	90	80	70	60	
9	11.0m x 27.0t				11.7m x 27.0t				9
10	27.0				27.0				10
12	27.0				27.0				12
14	27.0				27.0				14
16	27.0				26.4				16
18	25.5				24.8				18
20	23.9	23.5m x 22.7t			23.3				20
22	22.5				21.8	24.6m x			22
24	21.1	22.5			20.4	21.6t			24
26	19.5	20.4			19.1	20.2			26
28	17.8	18.6			17.8	18.4			28
30	16.2	17.1			16.5	16.9			30
32	14.6	15.8	35.6m x		15.2	15.7			32
34	11.2	14.7	13.5t		13.9	14.5	37.2m x		34
36	*35.0m x	13.7	13.3		11.2	13.6	12.5t		36
38	9.0t	12.8	12.5		36.8m x	12.7	12.2		38
40		12.1	11.7		9.9t	11.9	11.4		40
42		11.4	11.0		*37.8m x	11.2	10.7		42
44		42.3m x	10.4	46.7m x	8.3t	10.6	10.1		44
46		11.3t	9.9	9.2t		45.2m x	9.6	48.7m x	46
48		*43.3m x	9.3	8.9		10.3t	9.1	8.6t	48
50		9.8t	49.4m x	8.5		*46.2m x	8.6	8.4	50
52			9.0t	8.0		9.1t	8.2	7.9	52
54			*50.4m x	7.7			52.3m x	7.6	54
56			8.8t	7.3			8.2t	7.2	56
58				56.1m x			*53.3m x	6.9	58
60				7.3t			8.0t	59.0m x	60
62				*57.1m x				6.7t	62
				7.1t				*60.0m x	
								6.6t	

## ■ 46 m タワー



タワー長さ(m) タワージブ長さ(m) タワー角(°) 作業半径(m)	46								タワー長さ(m) タワージブ長さ(m) タワー角(°) 作業半径(m)
	27				30				
	90	80	70	60	90	80	70	60	
8	9.7m x 27.0t				10.4m x 27.0t				8
9	27.0				27.0				9
10	27.0				27.0				10
12	27.0				27.0				12
14	27.0				27.0				14
16	27.0				27.0				16
18	27.0	21.8m x 24.3t			26.4				18
20	25.3	24.3t			24.6	22.9m x 23.7t			20
22	23.3	24.2			22.9	23.7t			22
24	21.3	23.1			21.3	23.1			24
26	19.1	20.9			19.6	20.9			26
28	15.4	19.1			17.8	19.1			28
30	28.4m x 14.2t	17.6	33.5m x 14.8t		15.3	17.6			30
32		16.3	14.6		31.2m x 12.5t	16.3	35.1m x 13.9t		32
34	*29.4m x	15.1	14.6		12.5t	15.1			34
36	11.2t	14.1	13.6		*32.2m x 10.2t	14.1	13.5		36
38		37.0m x 13.7t	12.7			13.2	12.6		38
40			12.0			39.9m x 11.8			40
42		*38.0m x 12.5t	11.3	44.2m x 10.1t		12.5t	11.1		42
44			10.6			*40.9m x 11.4t	10.5	46.2m x 9.5t	44
46			44.7m x 10.4t	9.6			10.0		46
48			10.4t	9.1			47.6m x 9.1		48
50			*45.7m x 10.1t	8.7			9.5t	8.6	50
52				51.8m x 8.3t			*48.6m x 9.3t	8.2	52
54				8.3t				7.8	54
56				*52.8m x 8.1t				54.7m x 7.7t	56
58								*55.7m x 7.5t	58

・注記は、44 ページに記載されています。

■ 46 m タワー



(単位 t)

タワー長さ(m)	46								タワー長さ(m)
タワージブ長さ(m)	33				36				タワージブ長さ(m)
タワー角(°)	90	80	70	60	90	80	70	60	タワー角(°)
作業半径(m)									作業半径(m)
9	11.0m x				11.7m x				9
10	27.0t				27.0t				10
12	27.0				27.0				12
14	27.0				27.0				14
16	27.0				26.4				16
18	25.5				24.8				18
20	23.9				23.3				20
22	22.5				21.8	25.2m x			22
24	21.1	22.5			20.4	20.9t			24
26	19.5	20.4			19.1	20.1			26
28	17.8	18.6			17.8	18.4			28
30	16.2	17.1			16.5	16.9			30
32	14.6	15.8			15.2	15.6			32
34	11.2	14.7	36.7m x		13.9	14.5			34
36	*35.0m x	13.7	12.9t		11.3	13.5	38.3m x		36
38	9.2t	12.8	12.3		36.8m x	12.7	12.0t		38
40		12.1	11.6		10.0t	11.9	11.4		40
42		11.4	10.9		*37.8m x	11.2	10.7		42
44		42.8m x	10.3		8.4t	10.6	10.1		44
46		11.1t	9.7	48.2m x		45.7m x	9.6		46
48		*43.8m x	9.2	8.8t		10.1t	9.1	50.2m x	48
50		10.1t	8.8	8.4		*46.7m x	8.6	8.3t	50
52			50.5m x	8.0		9.3t	8.2	7.9	52
54			8.7t	7.6			53.4m x	7.5	54
56			*51.5m x	7.2			7.9t	7.2	56
58			8.4t	57.6m x			*54.4m x	6.8	58
60				7.0t			7.7t	6.5	60
62				*58.6m x				60.5m x	62
64				6.8t				6.5t	64
								*61.5m x	
								6.3t	

(単位 t)

タワー長さ(m)	46				タワー長さ(m)
タワージブ長さ(m)	39				タワージブ長さ(m)
タワー角(°)	90	80	70	60	タワー角(°)
作業半径(m)					作業半径(m)
10	12.3m x				10
12	26.9t				12
14	26.4				14
16	24.9				16
18	23.5				18
20	22.1				20
22	20.8				22
24	19.6	26.3m x			24
26	18.4	19.3t			26
28	17.2	17.8			28
30	16.1	16.4			30
32	15.0	15.2			32
34	13.8	14.1			34
36	12.7	13.1	39.8m x		36
38	11.0	12.3	11.3t		38
40	39.7m x	11.5	11.3		40
42	8.7t	10.9	10.6		42
44	*40.7m x	10.2	10.0		44
46	7.4t	9.7	9.5		46
48		9.2	9.0		48
50		48.6m x	8.5	52.2m x	50
52		9.1t	8.1	7.7t	52
54		*49.6m x	7.7	7.4	54
56		8.2t	7.4	7.0	56
58			56.3m x	6.7	58
60			7.3t	6.4	60
62			*57.3m x	6.1	62
64			7.1t	63.4m x	64
66				5.9t	66
68				*64.4m x	68
				5.8t	

・注記は、44 ページに記載されています。

■ 49 m タワー



タワー長さ(m)		49								タワー長さ(m)	
タワージブ長さ(m)		27				30				タワージブ長さ(m)	
タワー角(°)	作業半径(m)	90	80	70	60	90	80	70	60	タワー角(°)	作業半径(m)
8	9.7m x 27.0t									8	
9	27.0					10.4m x 27.0t				9	
10	27.0					27.0				10	
12	27.0					27.0				12	
14	27.0					27.0				14	
16	27.0					26.4				16	
18	27.0					24.6				18	
20	25.3	22.3m x 23.9t				24.6	23.4m x 23.4t			20	
22	23.3	23.0				22.9	23.1			22	
24	21.3	23.0				21.3	23.1			24	
26	19.1	20.9				19.6	20.9			26	
28	15.5	19.1				17.8	19.1			28	
30	28.4m x 14.3t	17.6				15.3	17.6			30	
32	14.3t	16.3	34.5m x 14.3t			31.2m x 12.5t	16.2			32	
34	*29.4m x 11.3t	15.1	13.6			12.5t	15.1	36.1m x 13.3t		34	
36		14.1	13.6			*32.2m x 10.2t	14.1	13.3t		36	
38		37.5m x 12.8t	12.7				13.2	12.5		38	
40		13.4t	12.0				12.4	11.7		40	
42		*38.5m x 12.8t	11.3	45.7m x 9.6t			40.4m x 12.2t	11.0		42	
44			10.6	9.5			10.4	47.7m x 8.9t		44	
46			45.7m x 10.2t	9.0			*41.4m x 11.2t	9.9	8.8	46	
48			10.2t	9.0				9.3	8.8	48	
50			*46.7m x 9.9t	8.5				48.6m x 9.2t	8.4	50	
52				8.1				9.2t	8.0	52	
54				53.3m x 7.9t				*49.6m x 9.0t	7.6	54	
56									7.2	56	
58				*54.3m x 7.7t					56.2m x 7.2t	58	
60									*57.2m x 7.0t	60	

タワー長さ(m)		49								タワー長さ(m)	
タワージブ長さ(m)		33				36				タワージブ長さ(m)	
タワー角(°)	作業半径(m)	90	80	70	60	90	80	70	60	タワー角(°)	作業半径(m)
9	11.0m x 27.0t					11.7m x 27.0t				9	
10	27.0					27.0				10	
12	27.0					27.0				12	
14	27.0					26.4				14	
16	27.0					26.4				16	
18	25.5					24.8				18	
20	23.9					23.3				20	
22	22.5	24.6m x 21.8t				21.8	25.7m x 20.3t			22	
24	21.1	21.8t				20.4	20.3t			24	
26	19.5	20.4				19.1	20.0			26	
28	17.8	18.6				17.8	18.3			28	
30	16.2	17.1				16.5	16.8			30	
32	14.6	15.8				15.2	15.5			32	
34	11.3	14.7	37.7m x 12.3t			13.9	14.4			34	
36	*35.0m x 9.1t	13.7	12.2			11.3	13.5	39.3m x 11.7t		36	
38		12.8	12.2			36.8m x 10.0t	12.6	11.4		38	
40		12.1	11.5				11.8	11.4		40	
42		11.4	10.8			*37.8m x 8.4t	11.1	10.7		42	
44		43.3m x 10.9t	10.2				10.5	10.1		44	
46		10.9t	9.6	49.7m x 8.3t			10.0	9.6		46	
48		*44.3m x 10.3t	9.1	8.2			46.2m x 9.9t	9.1	51.7m x 7.8t	48	
50			8.7	8.2				8.6		50	
52			51.5m x 8.4t	7.8			*47.2m x 9.1t	8.2	7.8	52	
54			8.4t	7.5				7.8	7.4	54	
56			*52.5m x 8.1t	7.1				54.4m x 7.7t	7.0	56	
58				6.8				7.7t	6.7	58	
60				59.1m x 6.6t				*55.4m x 7.6t	6.4	60	
62									6.1	62	
64				*60.1m x 6.5t					*63.0m x 6.0t	64	
66										66	

・注記は、44 ページに記載されています。



■ 49 m タワー



タワー長さ(m)		39				42				タワー長さ(m)	
タワージブ長さ(m)		39				42				タワージブ長さ(m)	
タワー角(°)	作業半径(m)	90	80	70	60	90	80	70	60	タワー角(°)	作業半径(m)
10	12.3m x					13.0m x				10	
12	26.9t					25.4t				12	
14	26.4					24.8				14	
16	24.9					23.4				16	
18	23.5					22.2				18	
20	22.1					21.0				20	
22	20.8					19.8				22	
24	19.6	26.8m x				18.7	27.9m x			24	
26	18.4	18.8t				17.6	17.4t			26	
28	17.2	17.8				16.6	17.3			28	
30	16.1	16.4				15.6	15.9			30	
32	15.0	15.1				14.6	14.7			32	
34	13.8	14.0				13.6	13.6			34	
36	12.7	13.1				12.6	12.7			36	
38	11.0	12.3	40.9m x			11.7	11.9			38	
40	39.7m x	11.5	11.0t			10.5	11.1	42.5m x		40	
42	8.8t	10.8	10.6			8.5	10.5	10.1t		42	
44	*40.7m x	10.2	10.0			42.5m x	9.9	9.7		44	
46	7.4t	9.7	9.4			7.9t	9.4	9.1		46	
48		9.2	8.9			*43.5m x	8.9	8.6		48	
50		49.1m x	8.5	53.7m x		6.7t	8.4	8.2		50	
52		8.9t	8.1	7.2t			8.0	7.8	55.8m x	52	
54		*50.1m x	7.7	7.2			*53.0m x	7.4	6.6t	54	
56		8.3t	7.3	6.8			7.6t	7.1	6.6	56	
58			57.3m x	6.5				6.7	6.3	58	
60			7.1t	6.2				6.5	6.0	60	
62			*58.3m x	5.9				60.2m x	5.7	62	
64			7.0t	5.7				6.4t	5.5	64	
66				64.9m x				*61.2m x	5.3	66	
68				5.6t				6.3t	67.8m x	68	
70				*65.9m x					5.1t	70	
72				5.5t					*68.8m x	72	
									5.0t		

■ 52 m タワー



タワー長さ(m)		27				30				タワー長さ(m)	
タワージブ長さ(m)		27				30				タワージブ長さ(m)	
タワー角(°)	作業半径(m)	90	80	70	60	90	80	70	60	タワー角(°)	作業半径(m)
8	9.7m x									8	
9	27.0t					10.4m x				9	
10	27.0					27.0t				10	
12	27.0					27.0				12	
14	27.0					27.0				14	
16	27.0					27.0				16	
18	27.0					26.4				18	
20	25.3	22.8m x				24.6				20	
22	23.3	23.6t				22.9				22	
24	21.3	23.0				21.3	23.0			24	
26	19.1	20.9				19.6	20.9			26	
28	15.6	19.1				17.8	19.1			28	
30	28.4m x	17.5				15.4	17.5			30	
32	14.3t	16.2	35.5m x			31.2m x	16.2			32	
34	*29.4m x	15.1	13.6t			12.6t	15.1	37.1m x		34	
36	11.2t	14.1	13.4			*32.2m x	14.1	12.7t		36	
38		13.2	12.5			10.3t	13.2	12.4		38	
40		38.1m x	11.7				12.4	11.6		40	
42		13.1t	11.1				41.0m x	10.9		42	
44		*39.1m x	10.4	47.2m x			12.0t	10.3		44	
46		12.0t	9.9	9.0t			*42.0m x	9.8	49.2m x	46	
48			46.7m x	8.9			11.2t	9.2	8.4t	48	
50			9.7t	8.4				49.6m x	8.2	50	
52			*47.7m x	8.0				8.9t	7.8	52	
54			9.4t	7.6				*50.6m x	7.5	54	
56				54.8m x				8.6t	7.1	56	
58				7.5t					57.7m x	58	
60				*55.8m x					6.8t	60	
62				7.3t					*58.7m x	62	
									6.7t		

・注記は、44 ページに記載されています。

## ■ 52 m タワー



タワー長さ(m)		52								タワー長さ(m)	
タワージブ長さ(m)		33				36				タワージブ長さ(m)	
タワー角(°)		90	80	70	60	90	80	70	60	タワー角(°)	
作業半径(m)										タワー角(°)	
9	11.0m x					11.7m x				9	
10	27.0t					27.0t				10	
12	27.0					27.0				12	
14	27.0					27.0				14	
16	27.0					26.4				16	
18	25.5					24.8				18	
20	23.9					23.3				20	
22	22.5	25.1m x				21.8				22	
24	21.1	21.3t				20.4	26.2m x			24	
26	19.5	20.4				19.1	19.9t			26	
28	17.8	18.6				17.8	18.3			28	
30	16.2	17.1				16.5	16.8			30	
32	14.6	15.8				15.2	15.6			32	
34	11.3	14.7				13.9	14.5			34	
36	*35.0m x	13.7	38.7m x			11.4	13.5			36	
38	9.3t	12.8	11.9t			36.8m x	12.6	40.3m x		38	
40		12.1	11.5			10.0t	11.9	11.3t		40	
42		11.4	10.8			*37.8m x	11.2	10.7		42	
44		43.8m x	10.2			8.4t	10.5	10.1		44	
46		10.8t	9.6				10.0	9.6		46	
48		*44.9m x	9.1	51.2m x			46.7m x	9.1		48	
50		10.3t	8.7	7.8t			9.8t	8.6	53.2m x	50	
52			8.2	7.7			*47.8m x	8.2	7.4t	52	
54			52.5m x	7.3			9.2t	7.8	7.2	54	
56			8.1t	7.0				55.4m x	6.9	56	
58			*53.5m x	6.6				7.5t	6.6	58	
60			7.9t	6.3				*56.4m x	6.3	60	
62				60.6m x				7.4t	6.0	62	
64				6.3t					63.5m x	64	
66				*61.6m x					5.8t	66	
68				6.1t					*64.5m x	68	
									5.7t		

タワー長さ(m)		52								タワー長さ(m)	
タワージブ長さ(m)		39				42				タワージブ長さ(m)	
タワー角(°)		90	80	70	60	90	80	70	60	タワー角(°)	
作業半径(m)										タワー角(°)	
10	12.3m x					13.0m x				10	
12	26.9t					25.4t				12	
14	26.4					24.8				14	
16	24.9					23.4				16	
18	23.5					22.2				18	
20	22.1					21.0				20	
22	20.8					19.8				22	
24	19.6	27.3m x				18.7				24	
26	18.4	18.3t				17.6	28.5m x			26	
28	17.2	17.8				16.6	16.9t			28	
30	16.1	16.3				15.6	15.8			30	
32	15.0	15.1				14.6	14.6			32	
34	13.8	14.0				13.6	13.6			34	
36	12.7	13.1				12.6	12.6			36	
38	11.0	12.2	41.9m x			11.7	11.8			38	
40	39.7m x	11.5	10.6t			10.6	11.1	43.5m x		40	
42	8.8t	10.8	10.6			8.5	10.4	9.7t		42	
44	*40.7m x	10.2	10.0			42.5m x	9.8	9.5		44	
46	7.4t	9.6	9.4			7.9t	9.3	9.0		46	
48		9.1	8.9			*43.5m x	8.8	8.5		48	
50		49.6m x	8.5			6.7t	8.4	8.1		50	
52		8.8t	8.0	55.2m x			8.0	7.7		52	
54		*50.7m x	7.7	6.7t			52.5m x	7.3	57.3m x	54	
56		8.3t	7.3	6.6			7.9t	7.0	6.1t	56	
58			7.0	6.3			*53.6m x	6.7	6.0	58	
60			58.3m x	6.0			7.4t	6.4	5.8	60	
62			6.9t	5.7				61.2m x	5.5	62	
64			*59.3m x	5.5				6.2t	5.3	64	
66			6.8t	5.3				*62.2m x	5.0	66	
68				66.4m x				6.1t	4.8	68	
70				5.2t					69.3m x	70	
72				*67.4m x					4.7t	72	
74				5.1t					*70.3m x	74	
									4.6t		

・注記は、44 ページに記載されています。

■ 52 m タワー



(単位 t)

タワー長さ(m)	52				タワー長さ(m)
タワージブ長さ(m)	45				タワージブ長さ(m)
タワー角(°)	90	80	70	60	タワー角(°)
作業半径(m)					作業半径(m)
10	13.6m x				10
12	21.3t				12
14	21.2				14
16	20.4				16
18	19.6				18
20	18.7				20
22	17.9				22
24	17.0				24
26	16.4	29.6m x			26
28	15.5	15.4t			28
30	14.8	15.2			30
32	14.0	14.0			32
34	13.2	13.0			34
36	12.4	12.1			36
38	11.6	11.3			38
40	10.8	10.6			40
42	10.0	10.0	45.1m x		42
44	8.4	9.4	8.9t		44
46	45.3m x	8.9	8.7		46
48	7.1t	8.4	8.2		48
50	*46.3m x	8.0	7.8		50
52	6.1t	7.6	7.4		52
54		7.3	7.0		54
56		55.4m x	6.7	59.3m x	56
58		7.0t	6.4	5.6t	58
60		*56.5m x	6.1	5.5	60
62		6.7t	5.8	5.2	62
64			5.6	5.0	64
66			64.1m x	4.8	66
68			5.6t	4.6	68
70			*65.1m x	4.4	70
72			5.5t	4.2	72
74				72.2m x	74
76				4.2t	76
				*73.2m x	
				4.1t	

・注記は、44 ページに記載されています。

■ 55 m タワー



タワー長さ(m)		55								タワー長さ(m)	
タワージブ長さ(m)		27				30				タワージブ長さ(m)	
タワー角(°)	作業半径(m)	90	80	70	60	90	80	70	60	タワー角(°)	作業半径(m)
8	9.7m x									8	
9	27.0t					10.4m x				9	
10	27.0					27.0t				10	
12	27.0					27.0				12	
14	27.0					27.0				14	
16	27.0					26.4				16	
18	27.0					24.6				18	
20	25.3	23.4m x				24.6				20	
22	23.3	23.3t				22.9	24.5m x			22	
24	21.3	23.0				21.3	22.4t			24	
26	19.1	20.8				19.6	20.8			26	
28	15.6	19.0				17.8	19.0			28	
30	28.4m x	17.5				15.4	17.5			30	
32	14.4t	16.2				31.2m x	16.2			32	
34	*29.4m x	15.1	36.6m x			12.6t	15.0			34	
36	11.4t	14.1	13.0t			*32.2m x	14.0	38.2m x		36	
38		13.2	12.4			10.3t	13.1	12.2t		38	
40		38.6m x	11.7				12.3	11.5		40	
42		12.9t	11.0				41.5m x	10.9		42	
44		*39.6m x	10.4				11.8t	10.2		44	
46		12.4t	9.8	48.7m x			*42.5m x	9.7		46	
48			47.7m x	8.6t			11.4t	9.2	50.7m x	48	
50			9.4t	8.3				8.7	8.0t	50	
52			*48.8m x	7.9				50.6m x	7.8	52	
54			9.1t	7.5				8.6t	7.4	54	
56				7.2				*51.6m x	7.0	56	
58				56.3m x				8.4t	6.7	58	
60				7.1t					59.2m x	60	
62				*57.3m x					6.5t	62	
64				7.0t					*60.2m x	64	
									6.4t		

タワー長さ(m)		55								タワー長さ(m)	
タワージブ長さ(m)		33				36				タワージブ長さ(m)	
タワー角(°)	作業半径(m)	90	80	70	60	90	80	70	60	タワー角(°)	作業半径(m)
9	11.0m x					11.7m x				9	
10	27.0t					27.0t				10	
12	27.0					27.0				12	
14	27.0					27.0				14	
16	27.0					26.4				16	
18	25.5					24.8				18	
20	23.9					23.3				20	
22	22.5	25.6m x				21.8				22	
24	21.1	20.8t				20.4	26.7m x			24	
26	19.5	20.4				19.1	19.4t			26	
28	17.8	18.6				17.8	18.3			28	
30	16.2	17.1				16.5	16.8			30	
32	14.6	15.8				15.2	15.6			32	
34	11.4	14.7				13.9	14.4			34	
36	*35.0m x	13.7	39.7m x			11.4	13.5			36	
38	9.2t	12.8	11.5t			36.8m x	12.6	41.3m x		38	
40		12.1	11.4			10.1t	11.8	10.9t		40	
42		11.4	10.7			*37.8m x	11.1	10.6		42	
44		10.7	10.1			8.5t	10.5	10.0		44	
46		44.4m x	9.6				10.0	9.5		46	
48		10.6t	9.1				47.3m x	9.0		48	
50		*45.4m x	8.6	52.7m x			9.6t	8.5		50	
52		10.0t	8.2	7.4t			*48.3m x	8.1	54.7m x	52	
54			53.5m x	7.2			9.3t	7.7	7.0t	54	
56			7.9t	6.9				7.4	6.8	56	
58			*54.5m x	6.5				56.4m x	6.5	58	
60			7.7t	6.3				7.3t	6.2	60	
62				6.0				*57.4m x	5.9	62	
64				62.1m x				7.1t	5.6	64	
66				6.0t					65.0m x	66	
68				*63.1m x					5.5t	68	
				5.8t					*66.0m x		
									5.4t		

・注記は、44 ページに記載されています。

■ 55 m タワー



(単位 t)

タワー長さ(m)	55								タワー長さ(m)
タワージブ長さ(m)	39				42				タワージブ長さ(m)
タワー角(°) 作業半径(m)	90	80	70	60	90	80	70	60	タワー角(°) 作業半径(m)
10	12.3m x				13.0m x				10
12	26.9t				25.4t				12
14	26.4				24.8				14
16	24.9				23.4				16
18	23.5				22.2				18
20	22.1				21.0				20
22	20.8				19.8				22
24	19.6	27.9m x			18.7				24
26	18.4	17.8t			17.6	29.0m x			26
28	17.2	17.8			16.6	16.5t			28
30	16.1	16.3			15.6	15.8			30
32	15.0	15.1			14.6	14.6			32
34	13.8	14.0			13.6	13.5			34
36	12.7	13.0			12.6	12.6			36
38	11.1	12.2			11.7	11.8			38
40	39.7m x	11.5	42.9m x		10.6	11.0			40
42	8.9t	10.8	10.2t		8.6	10.4	44.5m x		42
44	*40.7m x	10.2	9.9		42.5m x	9.8	9.4t		44
46	7.5t	9.6	9.3		8.0t	9.3	9.0		46
48		9.1	8.8		*43.5m x	8.8	8.5		48
50		8.7	8.4		6.8t	8.3	8.1		50
52		50.2m x	8.0			7.9	7.7		52
54		8.6t	7.6	56.7m x		53.1m x	7.3		54
56		*51.2m x	7.2	6.5t		7.7t	7.0	58.8m x	56
58		8.2t	6.9	6.3		*54.1m x	6.6	5.9t	58
60			59.3m x	6.0		7.5t	6.4	5.7	60
62			6.7t	5.7			6.1	5.5	62
64			*60.3m x	5.5			62.2m x	5.2	64
66			6.6t	5.3			6.1t	5.0	66
68				67.9m x			*63.2m x	4.8	68
70				5.0t			5.9t	4.6	70
72				*68.9m x				70.8m x	72
74				4.9t				4.5t	74
								*71.8m x	
								4.4t	

• 注記は、44 ページに記載されています。

## ■ 55 m タワー



		55				48				(単位 t)	
タワー長さ(m)	タワージブ長さ(m)									タワー長さ(m)	タワージブ長さ(m)
タワー角(°)	作業半径(m)	90	80	70	60	90	80	70	60	タワー角(°)	作業半径(m)
10	13.6m x									10	
12	21.1t					14.3m x				12	
14						19.4t				14	
16	20.2					18.7				16	
18	19.3					17.8				18	
20	18.5					16.9				20	
22	17.7					16.1				22	
24	16.9					15.4				24	
26	16.0					14.6				26	
28	15.2					13.9				28	
30	14.4	30.1m x				13.2	31.2m x			30	
32	13.7	15.0t				12.5	13.5t			32	
34	12.9	13.9				11.9	13.1			34	
36	12.2	12.9				11.2	12.2			36	
38	11.5	12.0				10.6	11.3			38	
40	10.7	11.2				10.0	10.6			40	
42	10.0	10.5				9.3	9.9			42	
44	8.4	9.9				8.7	9.3			44	
46	45.3m x	9.3	46.1m x			8.0	8.8	47.7m x		46	
48	7.1t	8.8	8.6t			6.5	8.3	7.9t		48	
50	*46.3m x	8.3	8.1			6.4	7.9	7.8		50	
52	6.1t	7.9	7.7			5.4	7.5	7.4		52	
54		7.5	7.3				7.1	7.0		54	
56		7.2	7.0			*49.1m x	6.7	6.7		56	
58		6.8	6.6			5.4t	6.4	6.4		58	
60		*57.0m x	6.3	60.8m x			6.1	6.1		60	
62		6.7t	6.0	5.5t			58.9m x	5.8	62.8m x	62	
64			5.8	5.3			6.0t	5.5	5.0t	64	
66			5.5	5.1			*59.9m x	5.3	4.8	66	
68			65.1m x	4.8			5.9t	5.1	4.6	68	
70			5.4t	4.6				4.9	4.4	70	
72			*66.1m x	4.4				*69.0m x	4.2	72	
74			5.3t	4.3				4.8t	4.0	74	
76				73.7m x					3.9	76	
78				4.1t					3.7	78	
80				*74.7m x					76.6m x	80	
				4.0t					3.7t		
									*77.6m x		
									3.6t		

・注記は、44 ページに記載されています。

■ 58 m タワー



タワー長さ(m)		58								タワー長さ(m)	
タワージブ長さ(m)		27				30				タワージブ長さ(m)	
タワー角(°)		90	80	70	60	90	80	70	60	タワー角(°)	
作業半径(m)										作業半径(m)	
8	9.7m x									8	
9	27.0t					10.4m x				9	
10	27.0					27.0t				10	
12	27.0					27.0				12	
14	27.0					27.0				14	
16	27.0					26.4				16	
18	27.0					24.6				18	
20	25.3	23.9m x				24.6				20	
22	23.3	23.0t				22.9	25.0m x			22	
24	21.3	23.0				21.3	21.8t			24	
26	19.1	20.8				19.6	20.8			26	
28	15.7	19.0				17.8	19.0			28	
30	28.4m x	17.5				15.5	17.5			30	
32	14.4t	16.2				31.2m x	16.1			32	
34	*29.4m x	15.0	37.6m x			12.6t	15.0			34	
36	11.3t	14.0	12.6t			*32.2m x	14.0	39.2m x		36	
38		13.1	12.4			10.3t	13.1	11.8t		38	
40		39.1m x	11.6				12.3	11.5		40	
42		12.7t	11.0				11.6	10.8		42	
44		*40.1m x	10.3				*43.0m x	10.2		44	
46		12.3t	9.8				11.2t	9.6		46	
48			9.3	50.2m x				9.1		48	
50			48.8m x	8.1t				8.7	52.2m x	50	
52			9.1t	7.7				51.7m x	7.5t	52	
54			*49.8m x	7.3				8.3t	7.2	54	
56			8.8t	7.0				*52.7m x	6.8	56	
58				57.8m x				8.1t	6.5	58	
60				6.7t					6.2	60	
62				*58.8m x					60.7m x	62	
64				6.5t					6.1t	64	
									*61.7m x		64
									6.0t		

タワー長さ(m)		58								タワー長さ(m)	
タワージブ長さ(m)		33				36				タワージブ長さ(m)	
タワー角(°)		90	80	70	60	90	80	70	60	タワー角(°)	
作業半径(m)										作業半径(m)	
9	11.0m x					11.7m x				9	
10	27.0t					27.0t				10	
12	27.0					27.0				12	
14	27.0					27.0				14	
16	27.0					26.4				16	
18	25.5					24.8				18	
20	23.9					23.3				20	
22	22.5					21.8				22	
24	21.1	26.1m x				20.4	27.3m x			24	
26	19.5	20.3t				19.1	18.9t			26	
28	17.8	18.6				17.8	18.3			28	
30	16.2	17.1				16.5	16.8			30	
32	14.6	15.8				15.2	15.6			32	
34	11.4	14.7				13.9	14.5			34	
36	*35.0m x	13.7				11.4	13.5			36	
38	9.4t	12.8	40.8m x			36.8m x	12.6			38	
40		12.0	11.0t			10.1t	11.8	42.4m x		40	
42		11.3	10.7			*37.8m x	11.1	10.4t		42	
44		10.7	10.0			8.5t	10.5	10.0		44	
46		44.9m x	9.5				10.0	9.4		46	
48		10.4t	9.0				47.8m x	8.9		48	
50		*45.9m x	8.5				9.5t	8.5		50	
52		10.1t	8.1	54.2m x			*48.8m x	8.0		52	
54			7.7	7.0t			9.2t	7.7	56.2m x	54	
56				54.6m x	6.7			7.3	6.5t	56	
58				7.6t	6.3			57.5m x	6.3	58	
60				*55.6m x	6.1			7.1t	6.0	60	
62				7.4t	5.8			*58.5m x	5.7	62	
64					63.6m x			6.9t	5.5	64	
66					5.6t				5.2	66	
68					*64.6m x				66.5m x	68	
70					5.5t				5.2t	70	
									*67.5m x		
									5.1t		

・注記は、44 ページに記載されています。

## ■ 58 m タワー



		58				42				(単位 t)	
タワー長さ(m)	タワージブ長さ(m)									タワー長さ(m)	タワージブ長さ(m)
タワー角(°)	作業半径(m)	90	80	70	60	90	80	70	60	タワー角(°)	作業半径(m)
10	12.3m x					13.0m x				10	
12	26.9t					25.4t				12	
14	26.4					24.8				14	
16	24.9					23.4				16	
18	23.5					22.2				18	
20	22.1					21.0				20	
22	20.8					19.8				22	
24	19.6					18.7				24	
26	18.4	28.4m x				17.6	29.5m x			26	
28	17.2	17.4t				16.6	16.1t			28	
30	16.1	16.3				15.6	15.7			30	
32	15.0	15.0				14.6	14.5			32	
34	13.8	13.9				13.6	13.5			34	
36	12.7	13.0				12.6	12.5			36	
38	11.1	12.2				11.7	11.7			38	
40		11.4				10.6	11.0			40	
42	39.7m x	10.7				8.6	10.4	45.5m x		42	
44	8.9t							9.2t		44	
46	*40.7m x	10.1	9.8			42.5m x	9.8	9.0		46	
48	7.5t	9.6	9.3			8.0t	9.2	8.6		48	
50		9.1	8.8			*43.5m x	8.7	8.1		50	
52		8.6	8.3			6.8t	8.3	7.7		52	
54		50.7m x	7.9				7.9	7.3		54	
56		8.5t	7.5				53.6m x	7.0		56	
58		*51.7m x	7.2	58.2m x			7.6t	6.6	60.3m x	58	
60		8.3t	6.8	6.1t			*54.6m x	6.3	5.5t	60	
62			6.5	5.8			7.4t	6.1	5.3	62	
64			60.4m x	5.5				6.3m x	5.0	64	
66			6.5t	5.3				5.9t	4.8	66	
68			*61.4m x	5.1				*64.3m x	4.6	68	
70			6.3t	4.9				5.8t	4.4	70	
72				69.4m x					4.2	72	
74				4.7t					72.3m x	74	
76				*70.4m x					4.2t	76	
				4.6t					*73.3m x		
									4.1t		

・注記は、44 ページに記載されています。



■ 58 m タワー



(単位 t)

タワー長さ(m)	58								タワー長さ(m)
タワージブ長さ(m)	45				48				タワージブ長さ(m)
タワー角(°)	90	80	70	60	90	80	70	60	タワー角(°)
作業半径(m)									作業半径(m)
10	13.6m x								10
12	20.8t				14.3m x				12
14					18.8t				14
16	19.8				18.1				16
18	19.2				17.3				18
20	18.4				16.5				20
22	17.6				15.8				22
24	16.8				15.1				24
26	16.0				14.4				26
28	15.2	30.6m x			13.8	31.7m x			28
30	14.4	14.6t			13.1	13.1t			30
32	13.7	13.8			12.5	13.0			32
34	12.9	12.8			11.9	12.0			34
36	12.2	11.9			11.2	11.2			36
38	11.5	11.1			10.6	10.5			38
40	10.7	10.5			10.0	9.8			40
42	10.0	9.8			9.3	9.2			42
44	8.4	9.3	47.1m x		8.7	8.7			44
46	45.3m x	8.8	8.4t		8.0	8.2	48.7m x		46
48	7.1t	8.3	8.2		6.5	7.8	7.7t		48
50	*46.3m x	7.9	7.7		48.1m x	7.4	7.4		50
52	6.1t	7.5	7.3		6.4t	7.0	7.1		52
54		7.1	7.0		*49.1m x	6.7	6.7		54
56		6.8	6.6		5.4t	6.4	6.4		56
58		56.5m x	6.3			6.1	6.1		58
60		6.7t	6.0	62.3m x		59.4m x	5.8		60
62		*57.5m x	5.8	5.1t		5.9t	5.5	64.3m x	62
64		6.6t	5.5	4.9		*60.4m x	5.3	4.6t	64
66			5.3	4.7			5.1	4.4	66
68			66.2m x	4.4			4.9	4.2	68
70			5.3t	4.3			69.0m x	4.0	70
72			*67.2m x	4.1			4.8t	3.8	72
74			5.2t	3.9			*70.1m x	3.7	74
76				75.2m x			4.6t	3.5	76
78				3.8t				3.4	78
80				*76.2m x				78.1m x	80
82				3.7t				3.4t	82
								*79.1m x	
								3.3t	

・注記は、44 ページに記載されています。

## ■ 58 m タワー



(単位 t)

タワー長さ(m)	58			タワー長さ(m)
タワージブ長さ(m)	51			タワージブ長さ(m)
タワー角(°)	90	80	70	タワー角(°)
作業半径(m)				作業半径(m)
12	14.9m x			12
14	17.8t			14
16	17.4			16
18	16.6			18
20	15.9			20
22	15.2			22
24	14.5			24
26	13.9			26
28	13.3			28
30	12.7	32.9m x		30
32	12.1	12.4t		32
34	11.6	11.9		34
36	11.0	11.1		36
38	10.5	10.4		38
40	9.9	9.7		40
42	9.3	9.1		42
44	8.8	8.6		44
46	8.3	8.1		46
48	7.7	7.7	50.3m x	48
50	6.3	7.3	7.2t	50
52	50.9m x	6.9	6.9	52
54	5.6t	6.6	6.5	54
56	*51.9m x	6.3	6.2	56
58	4.8t	6.0	5.9	58
60		5.7	5.6	60
62		5.5	5.3	62
64		62.3m x	5.1	64
66		5.4t	4.9	66
68		*63.3m x	4.7	68
70		5.3t	4.5	70
72			71.9m x	72
74			4.3t	74
76			*73.0m x	76
			4.2t	

・注記は、44 ページに記載されています。

■ 61 m タワー



タワー長さ(m)		61								タワー長さ(m)	
タワージブ長さ(m)		27				30				タワージブ長さ(m)	
タワー角(°)	作業半径(m)	90	80	70	60	90	80	70	60	タワー角(°)	作業半径(m)
8	9.7m x									8	
9	27.0t					10.4m x				9	
10	27.0					27.0t				10	
12	27.0					27.0				12	
14	27.0					27.0				14	
16	27.0					27.0				16	
18	26.0					25.4				18	
20	24.1					23.6				20	
22	22.4	24.4m x				22.1	25.5m x			22	
24	20.4	22.4t				20.5	21.3t			24	
26	18.3	20.8				18.9	20.8			26	
28	15.6	19.0				17.2	19.0			28	
30	28.4m x	17.5				15.1	17.4			30	
32	14.4t	16.1				31.2m x	16.1			32	
34	*29.4m x	15.0				12.5t	15.0			34	
36	11.5t	14.0	38.6m x			*32.2m x	14.0			36	
38		13.1	12.2t			10.4t	13.1	40.2m x		38	
40		39.6m x	11.7				12.3	11.4t		40	
42		12.4t	11.0				11.6	10.8		42	
44		*40.6m x	10.4				42.5m x	10.2		44	
46		12.0t	9.8				11.4t	9.7		46	
48			9.3	51.7m x			*43.5m x	9.2		48	
50			49.8m x	7.5t			11.1t	8.7	53.7m x	50	
52			8.9t	7.5				8.3	7.0t	52	
54			*50.8m x	7.1				52.7m x	6.9	54	
56			8.6t	6.8				8.1t	6.6	56	
58				6.5				*53.7m x	6.3	58	
60				59.3m x				7.9t	6.0	60	
62				6.3t					5.7	62	
64				*60.3m x					62.2m x	64	
66				6.1t					5.7t	66	
									*63.2m x		
									5.6t		

タワー長さ(m)		61								タワー長さ(m)	
タワージブ長さ(m)		33				36				タワージブ長さ(m)	
タワー角(°)	作業半径(m)	90	80	70	60	90	80	70	60	タワー角(°)	作業半径(m)
9	11.0m x					11.7m x				9	
10	27.0t					26.9t				10	
12	27.0					26.8				12	
14	27.0					26.0				14	
16	26.0					25.2				16	
18	24.3					23.8				18	
20	22.8					22.4				20	
22	21.4					21.1				22	
24	20.1	26.6m x				19.9	27.8m x			24	
26	18.8	19.8t				18.8	18.4t			26	
28	17.4	18.6				17.6	18.2			28	
30	16.0	17.1				16.5	16.7			30	
32	14.3	15.8				15.2	15.5			32	
34	11.4	14.7				13.9	14.4			34	
36	*35.0m x	13.7				11.5	13.4			36	
38	9.4t	12.8	41.8m x			36.8m x	12.5			38	
40		12.0	10.7t			10.1t	11.8	43.4m x		40	
42		11.3	10.7			*37.8m x	11.1	10.2t		42	
44		10.7	10.1			8.5t	10.5	10.0		44	
46		45.4m x	9.5				9.9	9.4		46	
48		10.3t	9.0				9.4	8.9		48	
50		*46.4m x	8.5				48.3m x	8.5		50	
52		10.0t	8.1	55.7m x			9.3t	8.0		52	
54			7.7	6.5t			*49.3m x	7.7	57.7m x	54	
56			55.6m x	6.4			9.1t	7.3	6.1t	56	
58			7.4t	6.1				7.0	6.0	58	
60			*56.6m x	5.8				58.5m x	5.8	60	
62			7.3t	5.6				6.9t	5.5	62	
64				5.3				*59.5m x	5.3	64	
66				65.1m x				6.7t	5.0	66	
68				5.2t					4.8	68	
70				*66.1m x					*69.0m x	70	
72				5.1t					4.7t	72	

・注記は、44 ページに記載されています。

## ■ 61 m タワー



タワー長さ(m)		61				42				タワー長さ(m)	
タワージブ長さ(m)		39				42				タワージブ長さ(m)	
タワー角(°)	作業半径(m)	90	80	70	60	90	80	70	60	タワー角(°)	作業半径(m)
10	12.3m x					13.0m x				10	
12	25.0t					23.4t				12	
14	24.5					23.1				14	
16	24.0					22.6				16	
18	22.9					21.6				18	
20	21.6					20.4				20	
22	20.4					19.3				22	
24	19.3					18.3				24	
26	18.3					17.4				26	
28	17.2	28.9m x				16.5				28	
30	16.1	16.2				15.6	15.6			30	
32	15.0	14.9				14.6	14.4			32	
34	13.8	13.9				13.6	13.4			34	
36	12.7	12.9				12.6	12.5			36	
38	11.1	12.1				11.7	11.7			38	
40		11.3				10.6	10.9			40	
42	39.7m x	10.7	45.0m x			8.6	10.3			42	
44	8.9t	10.1	9.5t			42.5m x	9.7	46.6m x		44	
46	*40.7m x	9.5	9.3			8.0t	9.2	8.9t		46	
48	7.5t	9.0	8.8			*43.5m x	8.7	8.5		48	
50		8.6	8.3			6.8t	8.2	8.1		50	
52		51.2m x	7.9				7.8	7.7		52	
54		8.3t	7.5				7.5	7.3		54	
56		*52.2m x	7.2	59.7m x			54.1m x	7.0		56	
58		8.1t	6.8	5.6t			7.5t	6.6	61.8m x	58	
60			6.5	5.6			*55.1m x	6.3	5.2t	60	
62				61.4m x	5.3		7.3t	6.0	5.2	62	
64				6.3t	5.1			5.8	4.9	64	
66				*62.4m x	4.9			64.3m x	4.7	66	
68				6.2t	4.7			5.8t	4.5	68	
70					4.5			*65.3m x	4.3	70	
72				70.9m x				5.6t	4.1	72	
74				4.4t					73.8m x	74	
76				*71.9m x					3.9t	76	
78				4.3t					*74.8m x	78	
									3.8t		

・注記は、44 ページに記載されています。

■ 61 m タワー



(単位 t)

タワー長さ(m)	61								タワー長さ(m)
タワージブ長さ(m)	45				48				タワージブ長さ(m)
タワー角(°)	90	80	70	60	90	80	70	60	タワー角(°)
作業半径(m)									作業半径(m)
10	13.6m x								10
12	20.6t				14.3m x				12
14					18.2t				14
16	19.6				17.6				16
18	18.9				16.7				18
20	18.2				16.1				20
22	17.5				15.5				22
24	16.8				14.8				24
26	15.9				14.2				26
28	15.1	31.1m x			13.5				28
30	14.4	14.2t			13.0	32.3m x			30
32	13.7	13.7			12.4	12.7t			32
34	12.9	12.7			11.7	11.9			34
36	12.2	11.9			10.9	11.1			36
38	11.5	11.1			10.4	10.3			38
40	10.7	10.4			9.9	9.7			40
42	9.9	9.8			9.3	9.1			42
44	8.4	9.2			8.7	8.6			44
46	45.3m x	8.7	48.2m x		8.0	8.1	49.7m x		46
48	7.1t	8.2	8.1t		6.5	7.7	7.5t		48
50	*46.3m x	7.8	7.7		48.1m x	7.3	7.4		50
52	6.1t	7.4	7.3		6.4t	6.9	7.0		52
54		7.1	7.0		*49.1m x	6.6	6.7		54
56		6.8	6.6		5.4t	6.3	6.4		56
58		57.0m x	6.3			6.0	6.1		58
60		6.6t	6.0	63.8m x		59.9m x	5.8		60
62		*58.0m x	5.8	4.6t		5.7t	5.5	65.8m x	62
64		6.5t	5.5	4.6		*60.9m x	5.3	3.9t	64
66			5.3	4.4		5.6t	5.0	3.9	66
68			67.2m x	4.2			4.8	3.7	68
70			5.1t	4.0			4.6	3.6	70
72			*68.2m x	3.8			70.1m x	3.4	72
74			5.0t	3.7			4.6t	3.2	74
76				3.5			*71.1m x	3.1	76
78				76.7m x			4.5t	3.0	78
80				3.5t				79.6m x	80
82				*77.7m x				2.9t	82
84				3.4t				*80.6m x	84
								2.8t	

・注記は、44 ページに記載されています。

## ■ 61 m タワー



(単位 t)

タワー長さ(m)	61			タワー長さ(m)
タワージブ長さ(m)	51			タワージブ長さ(m)
タワー角(°)	90	80	70	タワー角(°)
作業半径(m)				作業半径(m)
12	14.9m x			12
14	16.9t			14
16	16.5			16
18	15.8			18
20	15.1			20
22	14.4			22
24	13.8			24
26	13.2			26
28	12.7			28
30	12.1	33.4m x		30
32	11.6	11.9t		32
34	11.1	11.8		34
36	10.6	11.0		36
38	10.1	10.2		38
40	9.6	9.6		40
42	9.1	9.0		42
44	8.6	8.5		44
46	8.1	8.0		46
48	7.4	7.6	51.3m x	48
50	6.3	7.2	6.8t	50
52	50.9m x	6.8	6.8	52
54	5.6t	6.5	6.4	54
56	*51.9m x	6.2	6.1	56
58	4.8t	5.9	5.8	58
60		5.6	5.5	60
62		5.4	5.3	62
64		62.8m x	5.0	64
66		5.3t	4.8	66
68		*63.8m x	4.6	68
70		5.2t	4.4	70
72			4.2	72
74			73.0m x	74
76			4.1t	76
			*74.0m x	
			4.1t	

・注記は、44 ページに記載されています。

■ 64 m タワー



タワー長さ(m)		64								タワー長さ(m)	
タワージブ長さ(m)		27				30				タワージブ長さ(m)	
タワー角(°)	作業半径(m)	90	80	70	60	90	80	70	60	タワー角(°)	作業半径(m)
8	9.7m x					10.4m x				8	
9	27.0t					27.0t				9	
10	27.0					27.0				10	
12	27.0					26.4				12	
14	27.0					25.8				14	
16	27.0					24.6				16	
18	26.0					23.1				18	
20	24.3					21.6				20	
22	22.5	24.9m x				20.1				22	
24	20.7	21.9t				18.6	20.2			24	
26	18.7	20.7				17.0	19.0			26	
28	15.7	19.0				15.1	17.4			28	
30	28.4m x	17.4				31.2m x	16.1			30	
32	14.5t	16.1				12.5t	15.0			32	
34	*29.4m x	15.0				*32.2m x	14.0			34	
36	11.5t	14.0	39.6m x			10.4t	13.1	41.2m x		36	
38		13.1	11.8t				12.3	11.1t		38	
40		12.2	11.6				11.6	10.8		40	
42		40.1m x	11.0				43.0m x	10.2		42	
44		12.1t	10.3				10.8t	9.6		44	
46		*41.1m x	9.8				*44.0m x	9.1		46	
48		11.1t	9.3				10.0t	8.6		48	
50			8.8	53.2m x				8.2	55.2m x	50	
52			50.8m x	6.8t				7.9t	6.1t	52	
54			8.6t	6.6				*54.7m x	6.0	54	
56			*51.8m x	6.3				7.7t	5.7	56	
58			8.4t	6.0				7.7t	5.5	58	
60				5.7					5.2	60	
62				60.8m x					63.7m x	62	
64				5.6t					5.0t	64	
66				*61.8m x					*64.7m x	66	
68				5.5t					4.9t	68	

タワー長さ(m)		64								タワー長さ(m)	
タワージブ長さ(m)		33				36				タワージブ長さ(m)	
タワー角(°)	作業半径(m)	90	80	70	60	90	80	70	60	タワー角(°)	作業半径(m)
9	11.0m x					11.7m x				9	
10	25.8t					24.1t				10	
12	25.4					24.0				12	
14	24.7					23.3				14	
16	24.2					22.8				16	
18	23.7					22.3				18	
20	22.3					21.8				20	
22	21.0					20.6				22	
24	19.8	27.2m x				19.5				24	
26	18.5	18.4t				18.5	28.3m x			26	
28	17.3	18.0				17.4	16.9t			28	
30	15.9	17.0				16.3	16.2			30	
32	14.4	15.7				15.2	15.5			32	
34	11.5	14.6				14.0	14.3			34	
36	*35.0m x	13.6				11.5	13.4			36	
38	9.3t	12.7				36.8m x	12.5			38	
40		11.9	42.8m x			10.1t	11.7			40	
42		11.2	10.4t			*37.8m x	11.1	44.4m x		42	
44		10.6	10.0			8.5t	10.4	9.8t		44	
46		45.9m x	9.5				9.9	9.4		46	
48		9.7t	9.0				9.4	8.9		48	
50		*46.9m x	8.5				48.8m x	8.4		50	
52		9.2t	8.1				8.8t	8.0		52	
54			7.7	57.2m x			*49.8m x	7.6		54	
56			7.3	5.6t			8.0t	7.3	59.2m x	56	
58			56.6m x	5.5				6.9	5.0t	58	
60			7.2t	5.2				59.5m x	4.9	60	
62			*57.6m x	5.0				6.7t	4.7	62	
64			7.0t	4.7				*60.5m x	4.5	64	
66				4.5				6.5t	4.3	66	
68				66.6m x					4.1	68	
70				4.5t					69.5m x	70	
72				*67.6m x					4.0t	72	
74				4.4t					*70.5m x	74	
									3.9t		

・注記は、44 ページに記載されています。

## ■ 64 m タワー



		64				42				(単位 t)	
タワー長さ(m)	タワージブ長さ(m)									タワー長さ(m)	タワージブ長さ(m)
タワー角(°)	作業半径(m)	90	80	70	60	90	80	70	60	タワー角(°)	作業半径(m)
10	12.3m x					13.0m x				10	
12	22.5t					20.9t				12	
14	22.0					20.7				14	
16	21.4					20.2				16	
18	21.0					19.7				18	
20	20.6					19.3				20	
22	19.5					18.4				22	
24	18.5					17.5				24	
26	17.5					16.6				26	
28	16.6	29.4m x				15.8				28	
30	15.7	15.4t				15.0	30.5m x			30	
32	14.8	15.2				14.2	14.0t			32	
34	13.8	14.5				13.5	13.5			34	
36	12.7	13.8				12.6	13.0			36	
38	11.1	12.8				11.7	12.2			38	
40		12.0				10.6	11.4			40	
42	39.7m x	11.3				10.6	10.7			42	
44	8.9t	10.6				8.6	10.0			44	
46	*40.7m x	10.0				42.5m x	9.5	47.6m x		46	
48	7.5t	9.5	9.2			8.0t	8.9	8.2t		48	
50		9.0	8.7			*43.5m x	8.5	8.2		50	
52		8.5	8.3			6.8t	8.0	8.0		52	
54		51.7m x	7.8				7.6	7.7		54	
56		7.8t	7.5				7.3	7.3		56	
58		*52.7m x	7.1				54.6m x	7.0		58	
60		7.3t	6.8	61.2m x			7.0t	6.6		60	
62			6.5	4.6t			*55.6m x	6.3	63.3m x	62	
64			6.2	4.5			6.5t	6.0	4.0t	64	
66			62.4m x	4.3				5.8	4.0	66	
68			6.1t	4.1				65.3m x	3.8	68	
70			*63.4m x	3.9				5.6t	3.6	70	
72			6.0t	3.7				*66.3m x	3.4	72	
74				3.6				5.5t	3.3	74	
76				72.4m x					3.1	76	
78				3.5t					75.3m x	78	
80				*73.4m x					3.1t	80	
				3.5t					*76.3m x		
									3.0t		

・注記は、44 ページに記載されています。



■ 64 m タワー



		64							
タワー長さ(m)		64						タワー長さ(m)	
タワージブ長さ(m)		45			48			タワージブ長さ(m)	
タワー角(°)		90	80	70	90	80	70	タワー角(°)	
作業半径(m)							作業半径(m)		
10	13.6m x							10	
12	19.7t				14.3m x			12	
14	19.6				17.3t			14	
16	18.9				16.8			16	
18	18.2				16.2			18	
20	17.5				15.6			20	
22	16.7				15.0			22	
24	16.0				14.4			24	
26	15.2				13.8			26	
28	14.4				13.1			28	
30	13.7	31.7m x			12.5	32.8m x		30	
32	13.0	12.8t			11.8	11.6t		32	
34	12.3	12.7			11.2	11.3		34	
36	11.6	12.1			10.6	10.8		36	
38	10.9	11.6			10.0	10.2		38	
40	10.2	10.8			9.4	9.6		40	
42	9.4	10.1			8.8	9.0		42	
44	8.4	9.5			8.1	8.5		44	
46	45.3m x	9.0			7.4	8.0		46	
48	7.1t	8.5	49.2m x		6.5	7.6	50.8m x	48	
50	*46.3m x	8.0	7.3t		7.2	6.4t	6.4t	50	
52	6.1t	7.6	7.2		48.1m x	6.8	6.3	52	
54		7.2	7.1		6.4t	6.5	6.2	54	
56		6.9	6.9		*49.1m x	6.2	6.0	56	
58		6.6	6.6		5.4t	5.9	5.9	58	
60		57.5m x	6.3			5.6	5.7	60	
62		6.3t	6.0			60.4m x	5.5	62	
64		*58.5m x	5.7			5.5t	5.3	64	
66		6.1t	5.5			*61.4m x	5.0	66	
68			5.3			5.2t	4.8	68	
70			5.0				4.6	70	
72			68.2m x				71.1m x	72	
74			5.0t				4.4t	74	
76			*69.2m x				*72.1m x	76	
			4.9t				4.2t		

		64				
タワー長さ(m)		64			タワー長さ(m)	
タワージブ長さ(m)		51			タワージブ長さ(m)	
タワー角(°)		90	80	70	タワー角(°)	
作業半径(m)					作業半径(m)	
12	14.9m x					12
14	16.0t					14
16	15.6					16
18	14.9					18
20	14.3					20
22	13.6					22
24	13.1					24
26	12.5					26
28	12.1					28
30	11.5					30
32	10.9	33.9m x				32
34	10.4	10.4t				34
36	9.8	10.4				36
38	9.3	10.0				38
40	8.8	9.6				40
42	8.3	9.2				42
44	7.7	8.7				44
46	7.2	8.2				46
48	6.5	7.7				48
50	5.8	7.3				50
52	50.9m x	6.9		52.4m x		52
54	5.3t	6.6		5.6t		54
56	*51.9m x	6.2		5.5		56
58	4.8t	5.9		5.3		58
60		5.7		5.2		60
62		5.4		5.1		62
64		5.2		5.0		64
66		63.3m x		4.8		66
68		4.8t		4.6		68
70		*64.3m x		4.4		70
72		4.4t		4.2		72
74				4.0		74
76				3.8		76
78				*75.0m x		78
				3.7t		



・注記は、44 ページに記載されています。

# 分解時の質量と外形寸法

## 質量・外形寸法一覧表

輸送に際しては、関係法規を順守ください。  
「質量」は1ユニット当たりの質量を示しています。

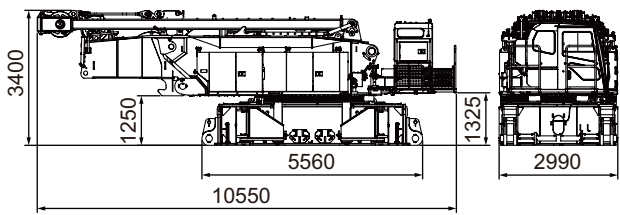
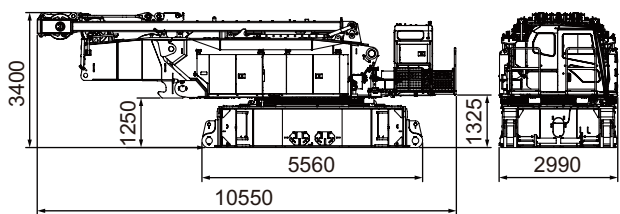
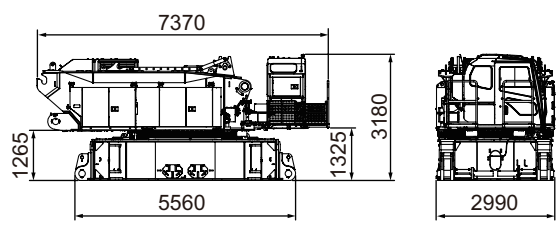
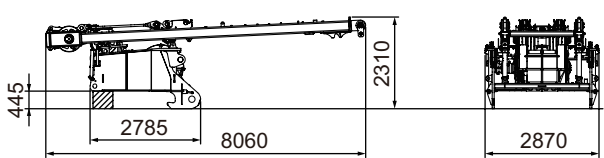
### 分解時の質量と外形寸法

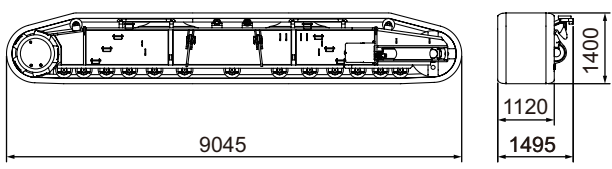
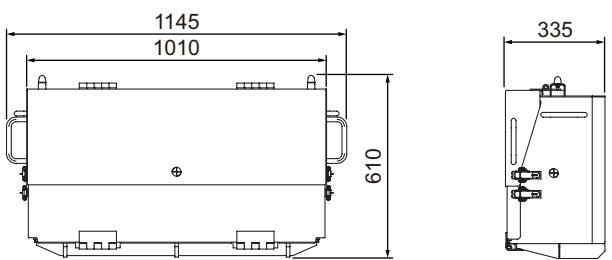
本体	個数	外形寸法 (mm)	質量 (kg)
フロント旋回フレーム + リヤ旋回フレーム マスト付き 起伏ワイヤロープ付き ジャッキ付き	1		44300
フロント旋回フレーム + リヤ旋回フレーム マスト付き 起伏ワイヤロープ付き ジャッキ無し	1		42200
フロント旋回フレーム ジャッキ無し	1		29700
リヤ旋回フレーム マスト付き 起伏ワイヤロープ付き	1	 <p>※スタンドは仮置き専用です。輸送時には  大の受け台をご用意ください。</p>	12500
クローラ (ASSY)	2		20600
工具箱 (左右クローラサイドフレーム 取付)	2		60

分解時の質量と外形寸法

本体	個数	外形寸法 (mm)	質量 (kg)
ジャッキビーム	4		510
カウンタウエイト (ベース)	1		9800
カウンタウエイト	12		7950
下部ブーム フロント (W1) ワイヤロープ付き リヤ (W2) ワイヤロープ付き バックストップ付き	1		13700
ブームバックストップ	2	<p>※図はクレーン時です。</p>	720
上部ブーム	1		3550
3 m 中間ブーム	1		710
6 m 中間ブーム	1		1160

分解時の質量と外形寸法

本体	個数	外形寸法 (mm)	質量 (kg)
9m 中間ブーム	1		1610
9m (B) 中間ブーム	1		2320
9m (C) 中間ブーム (レール付き)	1		1960
下部クレーンジブ ジブストラット付き	1		1040
上部クレーンジブ	1		580
6m 中間クレーンジブ	1		320
補助シーブ	1		350
上部タワーブーム リンク付き ガイドシーブ付き	1		1630
タワーガイド ローラ	1		400

分解時の質量と外形寸法

本体	個数	外形寸法 (mm)	質量 (kg)
タワーストラット	1		1800
下部タワージブ ジブバックストップ付き	1		1730
上部タワージブ ジブキャッチ付き	1		1480
3 m 中間タワージブ	1		290
9 m 中間タワージブ	1		720
ジブ下部スプレッダ ジブ上部スプレッダ	1		1450
200 t フック上部スプレッダ	1		600

分解時の質量と外形寸法

本体	個数	外形寸法 (mm)	質量 (kg)
200 t フック下部スプレッダ	1		400
200 t フック	1		3000
135 t フック	1		2600
80 t フック	1		2000
35 t フック	1		1070
13.5 t フック	1		620

# 装備品一覧

## 標準装備・オプション一覧

○：標準装備 ●：オプション —：設定無し

	項目	クレーン仕様	クレーン&タワー仕様
下部走行体	1120 mm 一体シュー	○	○
	ジャッキ	○	○
	クローラ連結装置	○	○
	シュー緊張装置 (シム調整式)	○	○
	シュー緊張装置 (油圧式)	●	●
上部旋回体	キャブ昇降キャットウォーク	○	○
	ハウス上面手摺	○	○
	アンダーカバー (ベッド下面)	○	○
	前照灯 (2 灯、右前)	○	○
	前照灯 (左前)	●	●
	バックミラー (左右)	○	○
	フリップシリンダ	○	○
	集中給脂装置 (旋回輪、ペンダントリンク用)	○	○
	起伏ドラムフランジカバー	○	○
	オートアイドルストップ	○	○
	エコモード	○	○
	キャットウォーク (折畳式・左右、ハンドレール付)	●	●
	ハンドレール (リヤフレーム用折畳式)	○	○
ハンドレール (フロントフレーム用差込式)	●	●	
キャブ	チルトキャブ (0 ~ 15°)	○	○
	エアコン	○	○
	サンバイザ	○	○
	サンシェード	○	○
	ウインドウオッシャ付ワイパ (前窓、天窓)	○	○
	マイク & スピーカ	○	○
	AM / FM ラジオ (時計付)	○	○
	室内灯	○	○
	カップホルダ	○	○
	24 V 電源ソケット (2 個)	○	○
	フロアカーペット	○	○
	水準器 (キャブ内・下部走行体)	○	○
	アームチェアレバー	○	○
	アクセルグリップ	○	○
	アクセルペダル (右側)	●	●
	ウインチ回転感知装置 [ フロント (W1)、リヤ (W2)、起伏 (W3) ]	○	○
	速度制御ダイヤル [ フロント (W1)、リヤ (W2)、起伏 (W3)、旋回 ]	○	○
	ブーム起伏操作ペダル	●	●
	旋回ブレーキ操作ペダル	●	●
	消火器 (ABC4 号)	●	●
	扇風機	●	●
燃焼式ヒータ	●	●	
脱出用ハンマ	○	○	
ブーム・フック類	16 m 基本ブーム (下部ブーム : 8.5 m、上部ブーム : 7.5 m)	○	○
	3 m 中間ブーム	●	●
	6 m 中間ブーム	●	●
	9 m 中間ブーム	●	●
	13 m クレーンジブ専用部品一式 [ 13 m 基本ジブ、フック過巻防止装置、ジブマスト ]	●	●
	6 m 中間クレーンジブ	●	●
	補助シーブ (1 車) [ 補助シーブ、フック過巻防止装置 ]	●	●
	64 m タワーブーム (下部タワーブーム : 8.5 m、中間タワーブーム : 3 m × 1、6 m × 1、9 m × 5、上部タワーブーム : 1.5 m)	—	○
	51 m タワージブ (下部ジブ : 9 m、中間タワージブ : 3 m × 2、9 m × 3、上部ジブ : 9 m)	—	○
	フロント (W1) / リヤ (W2) 自動ブレーキウインチ (下部ブーム搭載)	○	○
	フロント / リヤドラムフランジカバー	○	○
	ウインチロープ押さえ [ フロント (W1) / リヤウインチ (W2) ]	●	●
	ブームフットピン着脱シリンダ	○	○
	200 t [ 135 t フック (5 車) + スプレッダ (3 車) ]	○	○
	80 t フック (3 車)	●	●
	35 t フック (1 車)	●	○
	13.5 t フック	●	●

○：標準装備 ●：オプション ー：設定無し

項目		クレーン仕様	クレーン& タワー仕様
ワイヤロープ	フロント (W1) ウインチ (φ 28)	モノロープ EP 3xF (40)	●
		P・S (19) + 39xP・7	○
	リヤ (W2) ウインチ (φ 28)	IWRC 6xP・WS (31)	●
		モノロープ EP 3xF (40)	●
ブーム起伏 (W3) ウインチ (φ 28)	P・S (19) + 39xP・7	●	
	IWRC 6xP・WS (31)	○	
安全装備品	過負荷防止装置 (M/L)	○	○
	M/L 外部表示灯	○	○
	ゲートロックレバー	○	○
	個別ウインチ操作レバーロック [フロント (W1)、リヤ (W2)、起伏 (W3)、走行]	○	○
	オートドラムロック [起伏 (W3)]	○	○
	ウインチドラムロック [フロント (W1)、リヤ (W2)]	○	○
	旋回ロック	○	○
	旋回警報装置	○	○
	走行警報装置	○	○
	自動スローダウン (緩停止)	○	○
	ブーム過巻防止装置	○	○
	第2 過巻防止装置	○	○
	ボイスアラーム	○	○
	旋回ブレーキ掛け忘れ防止装置	○	○
	エンジン非常停止スイッチ (キャブ内、エンジン後部)	○	○
	揚程計	○	○
	旋回中立フリー / ブレーキモード切替	○	○
	フック過巻防止装置	○	○
	タワーストラット過巻防止装置	ー	○
	タワージブ過巻防止装置	ー	○
	タワージブ第2 過巻防止装置	ー	○
	タワージブ連結検出装置	ー	○
	タワージブ姿勢検出装置	ー	○
	旋回角度制限装置	●	●
	風速計 (上部ブーム)	○	○
	風速計 (上部タワーブーム)	ー	○
	航空障害灯 (不動光1 灯)	●	●
	無線通話装置 (1 対 2)	●	●
	上部ブームつり荷監視カメラ	●	●
	上部タワージブつり荷監視カメラ	ー	●
	ドラム&後方監視カメラ (カメラ 6 台、モニタ 2 台)	●	●
天窓ガード	●	●	
共通部品	ブームバックストップ	○	○
	ブーム角度計	○	○
	ブームつりピース	○	○
	リモートセンシング (携帯端末通信・データロギング装置)	○	○
	組立用パッド	●	●
	クローラ自力着脱用クイックドロー (シュー垂れ止め治具含む)	●	●
	減少カウンタウエイト仕様	● <sup>※2</sup>	● <sup>※2</sup>
	シュー垂れ止め治具	●	●
	キャブ昇降ラダー	●	●
	スカイウォーク (幅 500 mm、スタンション付)	●	●
	上部ブーム下面バッファ (プロテクタ)	●	●
	荷重表銘板 (ホワイトボード、下部ブーム取付)	●	●
	リーピングウインチ (4xF (30) φ 8 mm x 250 m)	●	●
	分解組立用玉掛ロープ (カウンタウエイト、クローラ、リヤフレーム、下部ブーム用)	●	●
	下部ブーム側面足場	●	●
	工具箱 (左右クローラサイドフレーム取付)	●	●
	追加工具 (大型ハンマ、クローバー、タガネ)	●	●
	追加予備品 (作動油フィルタ)	●	●
	その他	標準付属工具	○
標準予備品		○	○
指定色塗装		●	●

※ 1 タワージブ起伏ロープとして必須です。

※ 2 減少カウンタウエイト仕様は、クレーンジブを除くクレーン仕様時のみ使用できます。



Dotted lines for writing content.

A series of horizontal dashed lines for writing.



- カタログに掲載した内容は、予告なく変更することがあります。
- 本機の使用にあたっては取扱説明書を必ずお読み下さい。
- 機械を離れるときは、必ず作業装置を接地させるなどして、安全に心掛けて下さい。
- つり上げ荷重5トン以上の移動式クレーンの運転には「移動式クレーン運転免許証」が必要です。  
また、クレーン以外で使用する際は、該当する運転資格または講習等の終了証の取得者に限ります。

---

お問い合わせは…

## 住友重機械建機クレーン株式会社

本社：東京都台東区東上野6丁目9番3号  
Tel:03-3845-1396 Fax:03-3845-1394 <http://www.hsc-cranes.com>